

Main Index

VS	Index	Index	Page 01
Profiles			
A	VS	Specification Pages	Page A03-A06
		Technical Information	Page A07-A10
		Scale Profile Drawings	Page A11-A17
Accessories			
B	VS	Photos & Drawings	Page B02-B19
Sections			
C	VS	Scale Elevations	Page C01-C08
Not Used			
D	VS		
Construction Drawings			
E	VS	Outer Frame Assembly.....	Page E02
		Drainage	Page E03
		Attaching Spring Balances and Travel Stops.....	Page E04-E05
		Bottom Sash Assembly	Page E06
		Top Sash Assembly.....	Page E07
		Pivot Bar Carrier Fitting	Page E08
		Release Catch Fitting and Interlock Preparation.....	Page E09
		Bar Tilt Restrictor Fitting	Page E10
		Sash Lock and Keep	Page E11
		Listing Hooks and Pole Ring Fitting.....	Page E12
		Sash Insertion	Page E13
		Coupling and ACVL130 Fixing lug	Page E14
		ACVS100 Foam Location	Page E15
		Georgian Bar Information	Page E16
Sawing Tables			
F	VS	Standard Bottom Rail VS020 - Cutting Information	Page F02
		Deep Bottom Rail VS025 - Cutting Information	Page F03

Specification

GENERAL DESCRIPTION

The "VS600" vertical sliding window system described in this manual is suitable for domestic or commercial applications as replacement windows for existing buildings, and for installation into new buildings.

The system incorporates square cut assembly, concealed drainage, internally beaded vent frames and tilt-in facility for cleaning the external surface from inside the building.

The low line gaskets and extended polyamide thermal breaks help to provide excellent U Values and Window Energy Rating capable of achieving an 'C' Rating when used in conjunction with the correct double glazed unit. Please refer to the WER calculator for guidance.

RECOMMENDED DESIGN LIMITATIONS

Maximum Width: 1600mm (see below table)

Minimum Width: N/A

Maximum Overall Height: 2800mm (based on equal split)

Minimum Overall Height: 725mm (based on equal split)

Maximum Weight: 50kg (per sash)

Outer Frame Width	Maximum Outer Frame Height
750	2800
800	2800
850	2800
900	2800
950	2800
1000	2800
1050	2800
1100	2800
1150	2800
1200	2800
1250	2800
1300	2500
1350	2200
1400	2000
1450	1800
1500	1600
1550	1400
1600	1300

The above calculations are based on 6/16/6 units (30kg/m) packed no more than 75mm in from each upright.

The system is designed to be glazed with 28mm units only.

Specification

PROFILE SPECIFICATION

The window frames are constructed of aluminium alloy extrusion to BS EN 755-9 and BS EN 12020, extruded from 6063 T6 alloy. The internal and external extrusions are separated with a polyamide thermal break.

The external aluminium alloy extrusion is pre-treated and finished either:-

- a) Anodised to BS 3987: 1987, grade AA25 to a natural self colour.
- b) Polyester powder organic coating to BS 6496.

Please Note: The extrusions for the VS600 system are not available with a 'dual colour' finish.

GENERAL MANUFACTURING

Outer frames are made by cutting the head, cill and jamb profiles with accurate 90° square ends using Tungsten Carbide Tipped Saw Blades, operating at approximately 3000 rpm.

The joints are made by drilling a Ø5.5mm hole in the 'V' groove of the head & cill and screwed together using PUA028 and ACDR052 screws as shown in section E of this manual. All joints should be sealed using ACSIL04 sealant.

The sash joints are made by drilling a Ø5mm hole in the polyamide of the vertical members and screwed together using ACGSL084 screws as shown in section E of this manual. All joints should be sealed using ACSIL04 sealant.

On polyester powder coated finishes, great care should be taken to avoid getting gap sealer on visible surfaces and should be removed as soon as possible with a clean cloth.

Care should be exercised when using products not supplied by Smart Systems Ltd as no responsibility can be accepted. Warranties and performance may also be affected.

Specification

WINDOW DRAINAGE

As with all dry glazed systems, it is recommended that the window system is adequately drained and ventilated. Refer to drainage details in manual, if in doubt ask The Technical Department.

OUTER FRAME MANUFACTURING INFORMATION

Outer frames are made by cutting the head, cill and jamb profiles with accurate 90° square ends.

Corners are formed by drilling the head & cill sections using the drill jig shown in section E of this manual and by coating the cut faces to be joined with small gap sealant ACSIL04. The two ends are then brought together and fixed using a stainless steel self-tapper - PUA028 and ACDR052 screws are shown in this manual. The small gap sealer ensures a permanent joint and guards against the ingress of moisture and joint movement. After joining the corners, special care should be taken to ensure any excess sealer is removed from painted surfaces.

SASH MANUFACTURING INFORMATION

Sashes are made by cutting the head, cill and jamb profiles with accurate 90° square ends.

Corners are formed by drilling the jamb sections using the drill jig shown in section E of this manual and by coating the cut faces to be joined with small gap sealant ACSIL04. The two ends are then brought together and fixed using a stainless steel self-tapper - ACGSL084 screws are shown in this manual. The small gap sealer ensures a permanent joint and guards against the ingress of moisture and joint movement. After joining the corners, special care should be taken to ensure any excess sealer is removed from painted surfaces.

Specification

IRONMONGERY

VS600 is deigned around existing vertical slider hardware from Caldwell Hardware (UK) Limited. The vertical slider hardware shown in this manual provides the Caldwell part numbers to allow for direct ordering:

Caldwell Hardware (UK) Limited
Herald Way
Coventry
CV3 2RQ
Tel: 024 7643 7900
Fax: 024 7643 7969
Email: sales@caldwell.co.uk
Web Site: www.caldwell.co.uk

GLAZING

All beads are cut to suit the glazing aperture on the fully assembled window for glazing either at factory or on site as required. It is advisable to use a gasket roller when using low-line gaskets to ensure a neat finish.

INTERNALLY BEADED GLAZING







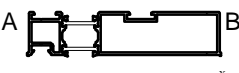



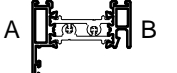

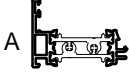



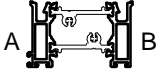

Glazing beads are fitted to openings by cutting the horizontal beads square to head and cill of each vent and fixed light area. Vertical beads are cut square at both ends. Insert bottom beads and two setting blocks to ensure glass will be centralized in vertical dimension of opening (glazing blocks must be full width of cavity to fully support glass or sealed unit), then insert top bead followed by side beads. Finish glazing by insertion of internal gaskets all round.

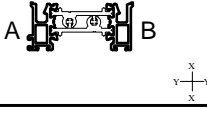
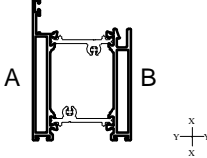
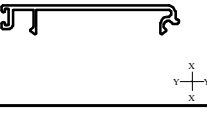

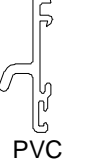
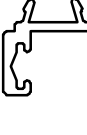



VS600 Window Weather Performance (BS6375-1)



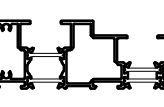
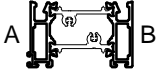
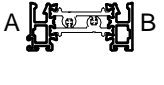
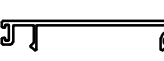
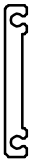
BS EN 1026: 2000 Air Permeability:	TBA
BS EN 1027: 2000 Watertightness:	TBA
BS EN 12211: 2000 Resistance to Wind Load:	TBA

VS600 Window U Values

Please refer to the Smart Systems' Document L White Paper or contact the Technical Department.

Number	Picture	Page	Perim. mm	Mec. mm	Ix(cm4) wx(cm3)	Iy(cm4) wy(cm3)	Length	Pack pr.	MF	SA	KL	HP	M	
EF422	 PVC 	A14	-	-	- ----- -	- ----- -	7	1	✓					
VL75	 	A14	55	-	- ----- -	- ----- -	6.5	10	✓	✓				
VS010	 	A11	470	148	126.18 ----- 17.4	5.83 ----- 4.56	6.5	1	✓	✓	✓	✓		
VS011	 	A11	433	62	98.43 ----- 14.17	6.65 ----- 4.70	6.5	1	✓	✓	✓	✓		
VS012	 	A12	737	211	189.28 ----- 28.75	30.83 ----- 12.47	6.5	1	✓	✓	✓	✓		
VS020	 	A14	286	70	12.96 ----- 4.60	2.80 ----- 1.88	5	1	✓	✓	✓	✓		
VS021	 	A14	146	40	7.92 ----- 2.53	0.67 ----- 0.61	5	1	✓	✓	✓	✓		
VS022	 	A14	120	20	7.38 ----- 2.70	0.67 ----- 0.61	5	1	✓	✓	✓	✓		
VS023	 	A15	315	85	15.23 ----- 5.47	3.94 ----- 2.28	5	1	✓	✓	✓	✓		
									A = Outside B = Inside		MF = Mill Finish SA = Silver Anodised KL = Basic Colour HP = Special Colour M = Dual Colour			

Number	Picture	Page	Perim. mm	Mec. mm	lx(cm4) wx(cm3)	ly(cm4) wy(cm3)	Length	Pack pr.	MF	SA	KL	HP	M	
VS024		A15	275	66	12.34 ----- 4.44	1.54 ----- 1.17	5	1	✓	✓	✓	✓		
VS025		A16	427	139	23.59 ----- 8.60	21.75 ----- 6.82	5	1	✓	✓	✓	✓		
VS030N		A17	179	66	4.81 ----- 1.59	0.08 ----- 0.35	5	1	✓	✓	✓	✓		
VS031	 PVC	A14	-	-	- ----- -	- ----- -	5	1	✓					
VS032	 PVC	A14	-	-	- ----- -	- ----- -	5	1	✓					
VS041		A17	78	45	- ----- -	- ----- -	5	1	✓	✓	✓	✓		
VS044		A17	99	34	- ----- -	- ----- -	5	1	✓	✓	✓	✓		
VS045		A17	91	30	- ----- -	- ----- -	5	1	✓	✓	✓	✓		
VS046		A17	75	20	- ----- -	- ----- -	5	1	✓	✓	✓	✓		
									A = Outside B = Inside	MF = Mill Finish SA = Silver Anodised KL = Basic Colour HP = Special Colour M = Dual Colour				

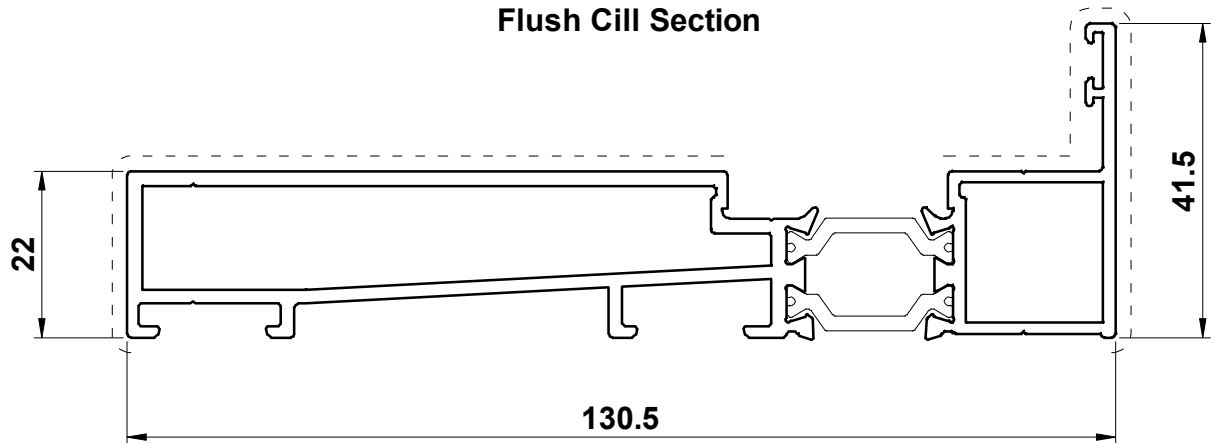
Number	Picture	Page	Perim. mm	Mec. mm	lx(cm4) wx(cm3)	ly(cm4) wy(cm3)	Length	Pack pr.	MF	SA	KL	HP	M	
VS052	 <small>X Y X Y</small>	A17	131	41	- ----- -	- ----- -	5	1	✓	✓	✓	✓		
VS110	 <small>A B</small> <small>X Y X Y</small>	A13	560	256	310.68 ----- 31.23	7.98 ----- 4.30	6.5	1	✓	✓	✓	✓		
VS112	 <small>X Y X Y</small>	A12	641	203	166.23 ----- 24.97	19.63 ----- 9.49	6.5	1	✓	✓	✓	✓		
VS123	 <small>A B</small> <small>X Y X Y</small>	A15	318	126	16.67 ----- 5.89	4.13 ----- 2.40	5	1	✓	✓	✓	✓		
VS124	 <small>A B</small> <small>X Y X Y</small>	A15	277	108	13.69 ----- 4.83	1.61 ----- 1.31	5	1	✓	✓	✓	✓		
VS130	 <small>X Y X Y</small>	A17	179	66	4.81 ----- 1.59	0.08 ----- 0.35	5	1	✓	✓	✓	✓		
W20165	 <small>X Y X Y</small>	A17	68	32	- ----- -	- ----- -	4	1	✓	✓	✓	✓		
									A = Outside B = Inside		MF = Mill Finish SA = Silver Anodised KL = Basic Colour HP = Special Colour M = Dual Colour			

Number	Picture	Page	Perim. mm	Mec. mm	lx(cm4) wx(cm3)	ly(cm4) wy(cm3)	Length	Pack pr.	MF	SA	KL	HP	M	
									A = Outside B = Inside	MF = Mill Finish SA = Silver Anodised KL = Basic Colour HP = Special Colour M = Dual Colour				

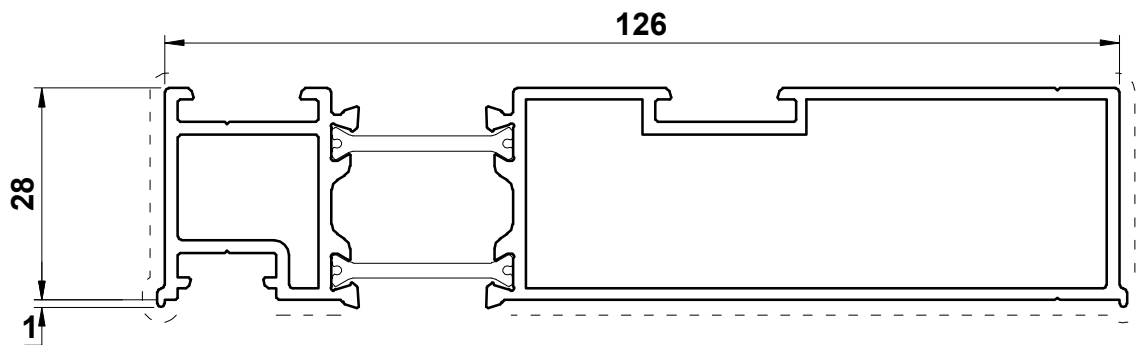
Primary Visible Side

Secondary Visible Side

VS010
Flush Cill Section



VS011
Head Section

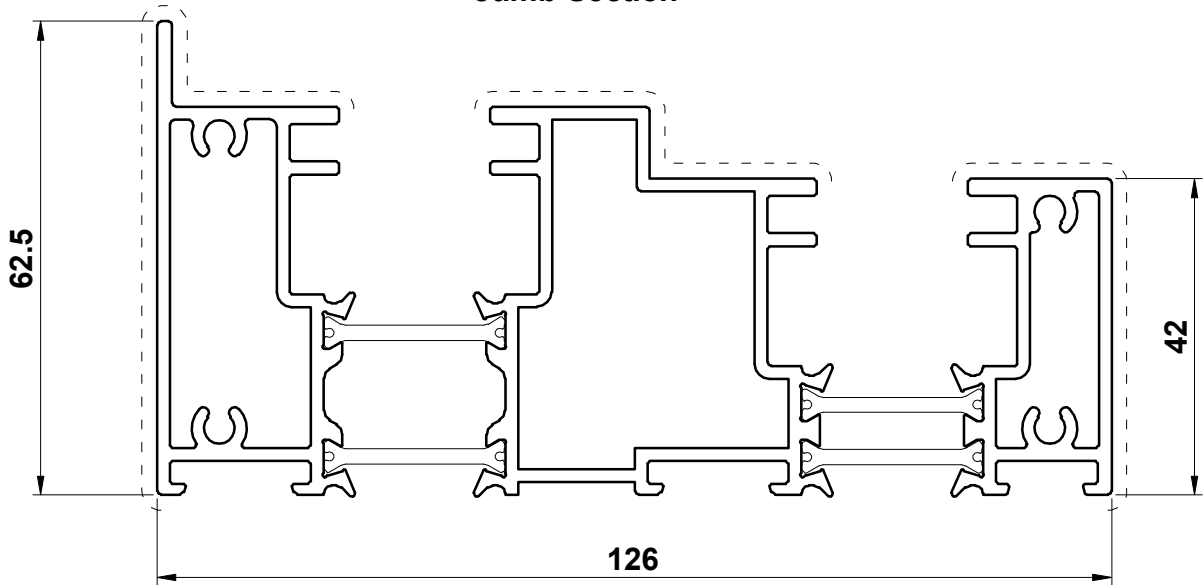


Scale 1:1

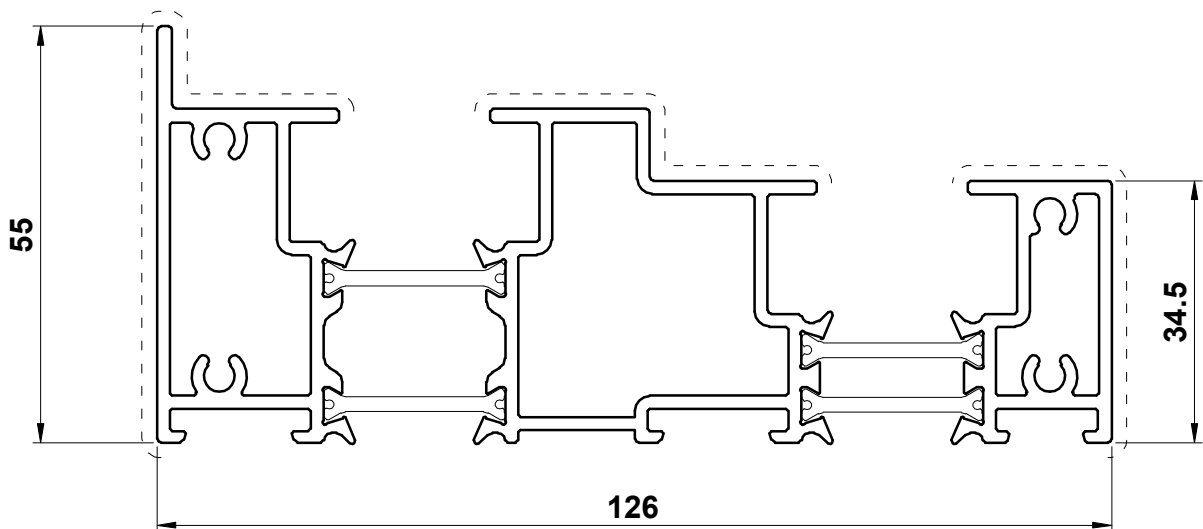
Primary Visible Side

Secondary Visible Side

VS012
Jamb Section



VS112
Slim Jamb Section



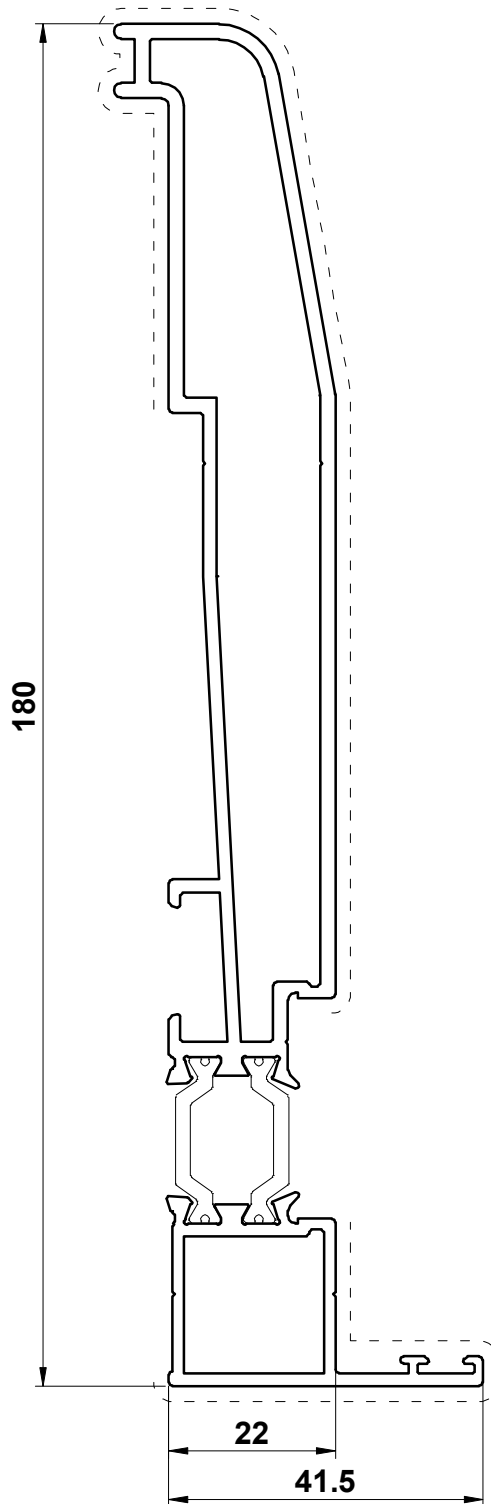
Scale 1:1

Primary Visible Side

Secondary Visible Side

VS110

180mm Cill Section



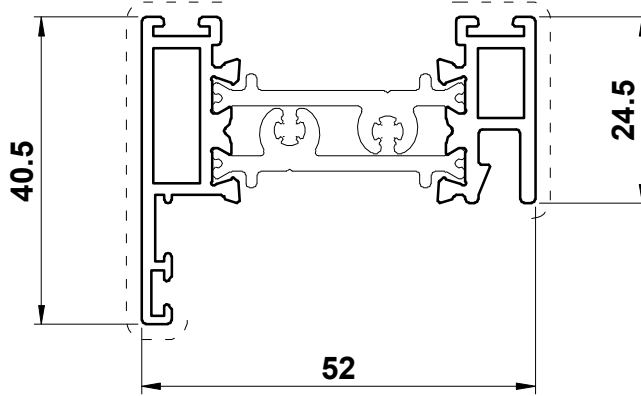
Scale 1:1

Primary Visible Side

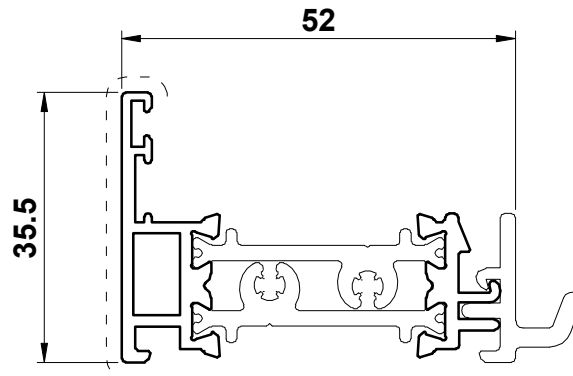
Secondary Visible Side

VS020

Top Rail of Top Sash &
Bottom Rail of Bottom Sash

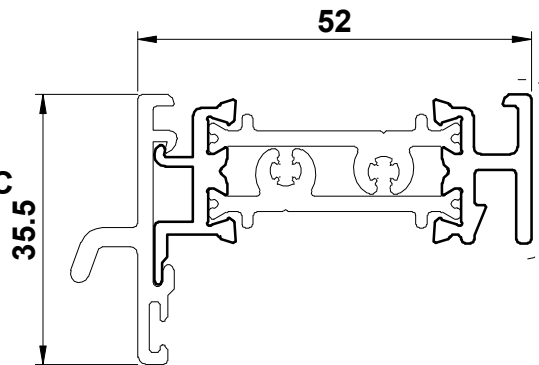


VS021
Bottom Rail
of Top Sash



VS031
External Interlock PVC
Black Only

VS032
Internal Interlock PVC
Black Only



VS022
Top Rail
of Bottom Sash

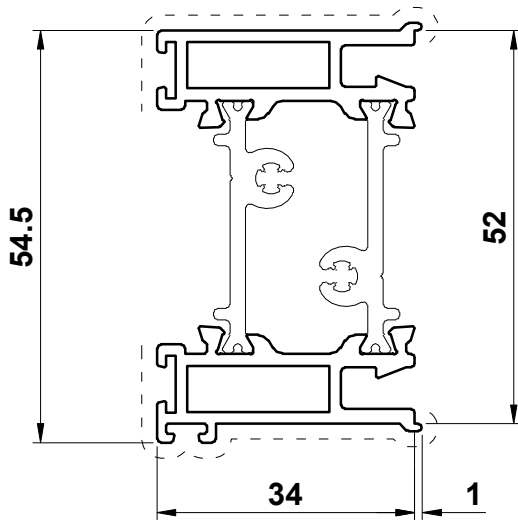
Scale 1:1

Primary Visible Side

Secondary Visible Side

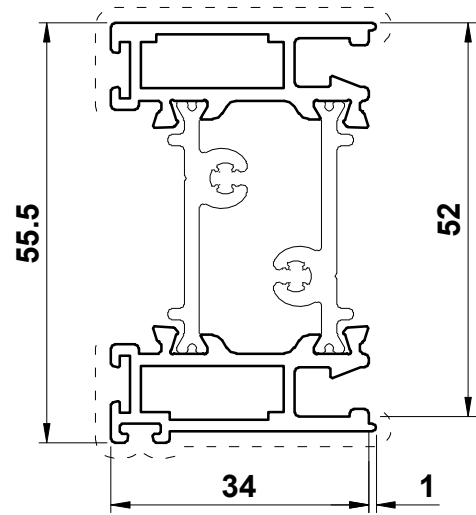
VS023

Vertical Member
of Bottom Sash



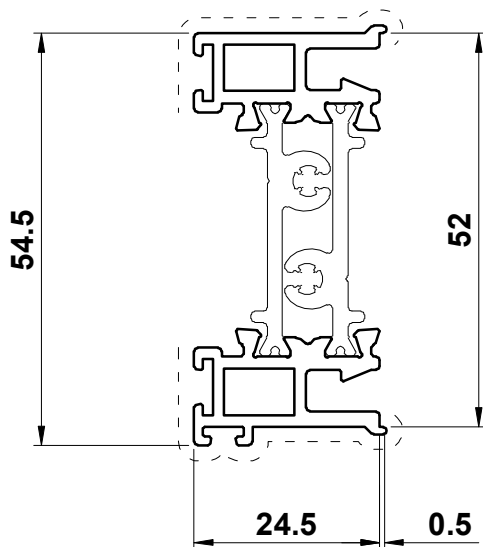
VS123

Flat Vertical Member
of Bottom Sash



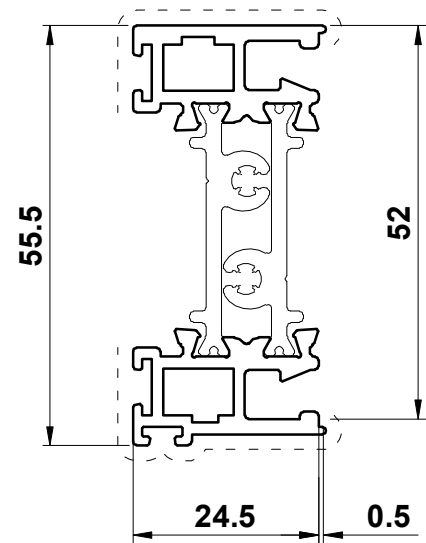
VS024

Vertical Member
of Top Sash



VS124

Flat Vertical Member
of Top Sash



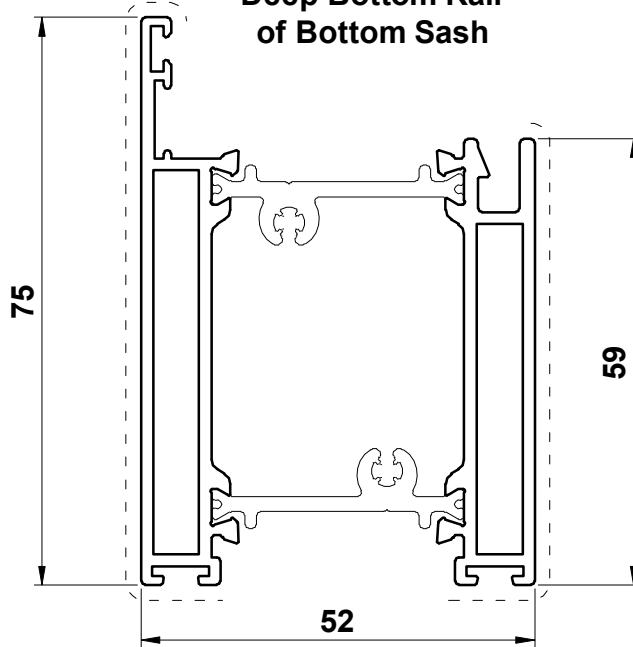
Scale 1:1

Primary Visible Side

Secondary Visible Side

VS025

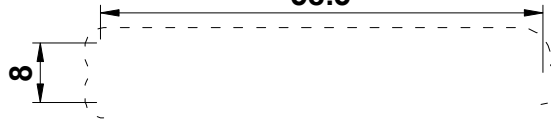
Deep Bottom Rail
of Bottom Sash



VS030N

Interlock Cap

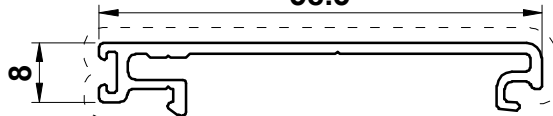
58.5



VS130

Flat Interlock Cap

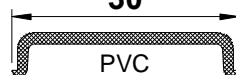
58.5



EF422

Cill Insert Strip

30



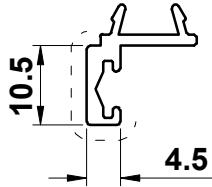
Scale 1:1

Primary Visible Side

Secondary Visible Side

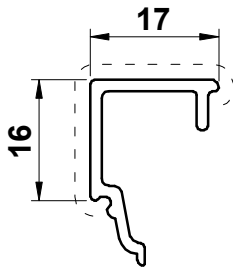
VS041

External Woolpile Carrier



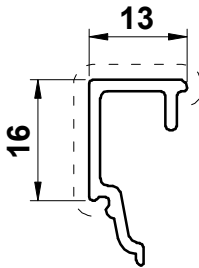
VS044

Internal Bead
(24mm Units)



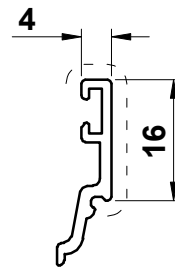
VS045

Internal Bead
(28mm Units)



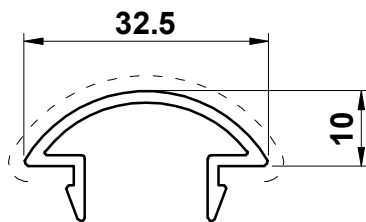
VS046

External Bead
(28mm Units)



VS052

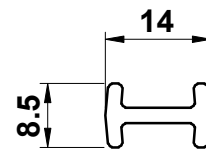
Travel Stop



(End Caps = ACVS052)

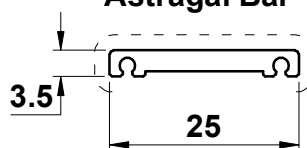
VL75

Coupling Clip



W20165

Astragal Bar



Scale 1:1

Primary Visible Side

Secondary Visible Side

Scale 1:1

Section B

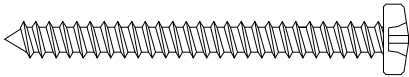

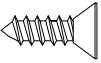



Image	Part Code	Pack	Unit	Application	Colour
	ACDR052 No. 10 x 50 S/S Self Tapping Pan Head Screw	100	pack		MF
					SA
					KL
					HP
					M
					GOZ
					W
					Z
					PC
					
SA					
KL					
HP					
M					
GOZ					
W					
Z					
PC					
	ACET067 No. 7 x 13 S/S Self Tapping CSK Screw	100	pack		
					SA
					KL
					HP
					M
					GOZ
					W
					Z
					PC
					
SA					
KL					
HP					
M					
GOZ					
W					
Z					
PC					
	ACET190 4.3 x 45mm CSK S/S Polyamide Screw	1000	pack		
					SA
					KL
					HP
					M
					GOZ
					W
					Z
					PC
					 <small>T-BARS ACVG65=2.5mm ACVG66=3.0mm ACVL150=4.0mm</small>








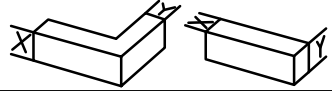
Image	Part Code	Pack	Unit	Application	Colour	
	ACET290 4.3 x 20mm CSK S/S Polyamide Screw	1000	pack		MF	
					SA	
					KL	
					HP	
					M	
					GOZ	
					W	
					Z	
					PC	
	ACET390 4.3 x 25mm CSK S/S Polyamide Screw	1000	pack		MF	
					SA	
					KL	
					HP	
					M	
					GOZ	
					W	
					Z	
					PC	
	ACET490 4.3 x 16mm CSK S/S Polyamide Screw	1000	pack		MF	
					SA	
					KL	
					HP	
					M	
					GOZ	
					W	
					Z	
					PC	
	ACET840 5mm Low Line Wedge	150	m		MF	
					SA	
					KL	
					HP	
					M	
					GOZ	
					W	
					Z	
					PC	
	ACET842 3mm Low Line External Gasket	200	m		MF	
					SA	
					KL	
					HP	
					M	
					GOZ	
					W	
					Z	
					PC	
	T-BARS ACVG65=2.5mm ACVG66=3.0mm ACVL150=4.0mm		Screw (GxL)	MF = Mill Finish SA = Silver Anodised KL = Basic Colour HP = Special Colour M = Dual Colour GOZ = Gold PC = Polished Chrome W = White Z = Black		


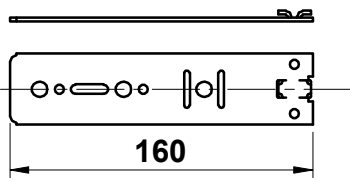
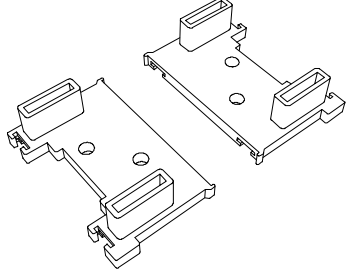
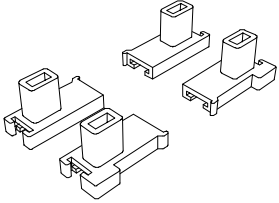
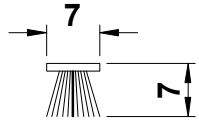


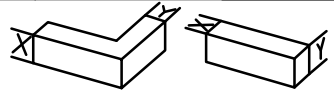
Image	Part Code	Pack	Unit	Application	Colour	
	ACGSL084 Sash Screw	100	pack		MF	
					SA	
					KL	
					HP	
					M	
					GOZ	
					W	
					Z	
PC						
	ACVL130 Galvanised Steel Fixing Strap 160mm x 38mm x 2mm	1	each	VS010 VS011 VS012 VS110	MF	
					SA	
					KL	
					HP	
					M	
					GOZ	
					W	
					Z	
PC						
	ACVS023 VS023 End Caps	10	pairs	VS023	MF	
					SA	
					KL	
					HP	
					M	
					GOZ	
					W	✓
					Z	✓
PC						
	ACVS024 VS024 End Caps	10	sets	VS024	MF	
					SA	
					KL	
					HP	
					M	
					GOZ	
					W	✓
					Z	✓
PC						
	ACVS032B 7 x 7mm Woolpile in Black with Fin	150	m		MF	
					SA	
					KL	
					HP	
					M	
					GOZ	
					W	
					Z	✓
PC						
 <small>T-BARS ACVG65=2.5mm ACVG66=3.0mm ACVL150=4.0mm</small>	 <small>Screw (Grub)</small>	MF = Mill Finish GOZ = Gold SA = Silver Anodised PC = Polished Chrome KL = Basic Colour W = White HP = Special Colour Z = Black M = Dual Colour				

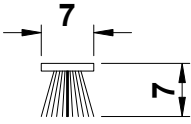
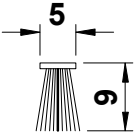
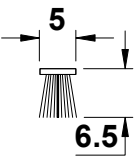
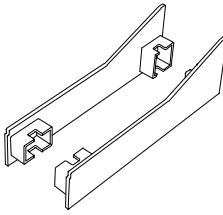
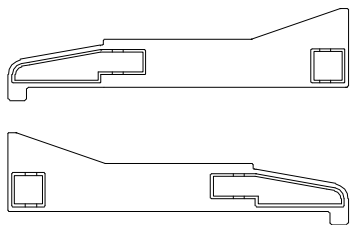


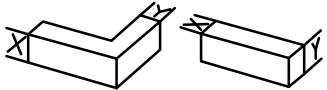
Image	Part Code	Pack	Unit	Application	Colour	
	ACVS032W 7 x 7mm Woolpile in White with Fin	150	m		MF	
					SA	
					KL	
					HP	
					M	
					GOZ	
					W	✓
					Z	✓
PC						
	ACVS033 5 x 9mm Woolpile in Black with Fin	150	m		MF	
					SA	
					KL	
					HP	
					M	
					GOZ	
					W	
					Z	✓
PC						
	ACVS034 5 x 6.5mm Woolpile in Black with Fin	150	m		MF	
					SA	
					KL	
					HP	
					M	
					GOZ	
					W	
					Z	
PC						
	ACVS040 VS010 End Caps	10	pairs		MF	
					SA	
					KL	
					HP	
					M	
					GOZ	
					W	✓
					Z	✓
PC						
	ACVS041 VS110 End Caps	10	pairs		MF	
					SA	
					KL	
					HP	
					M	
					GOZ	
					W	✓
					Z	✓
PC						
 <small>T-BARS ACVG65=2.5mm ACVG66=3.0mm ACVL150=4.0mm</small>	 <small>Screw (Grub)</small>	MF = Mill Finish SA = Silver Anodised KL = Basic Colour HP = Special Colour M = Dual Colour		GOZ = Gold PC = Polished Chrome W = White Z = Black		
						

Image	Part Code	Pack	Unit	Application	Colour
	ACVS042 Balance Fixing Kit: 4 x Fixing Plate 2 x M5 x 35 screws 2 x M5 x 40 screws 4 x ACET067 self tappers	10	sets		MF
					SA
	ACVS043 Polyamide Support Block	12	pack		KL
					HP
	ACVS050 Draught Excluder & Foam Insert	1	pair	VS023	M
					GOZ
	ACVS051 Foam Insert for Spring Balance	50	pack	VS012	W
					Z
	ACVS052 Travel stop End Cap	20	pack	VS052	W
					Z
	MF = Mill Finish SA = Silver Anodised KL = Basic Colour HP = Special Colour M = Dual Colour		GOZ = Gold PC = Polished Chrome W = White Z = Black		


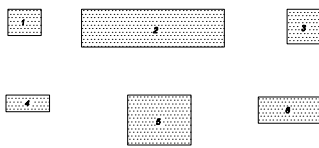
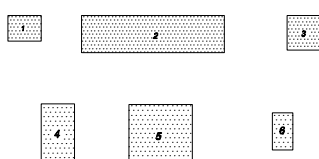
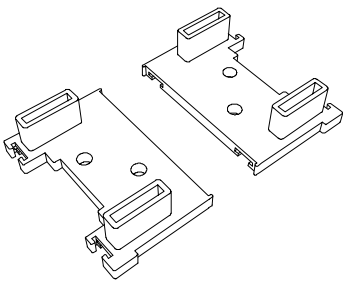
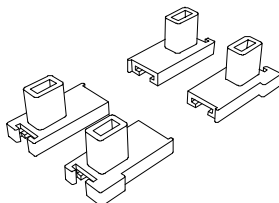


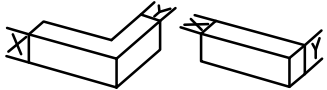
Image	Part Code	Pack	Unit	Application	Colour	
	ACVS057 Bridge Packer	10	pack		MF	
					SA	
					KL	
					HP	
					M	
					GOZ	
					W	
					Z	
					PC	
 <p>All 1250mm Lengths</p>	ACVS100 Foam Insulation See section E for more details	1	pack	VS010 VS011 VS012	MF	
					SA	
					KL	
					HP	
					M	
					GOZ	
					W	
					Z	
					PC	
 <p>All 1250mm Lengths</p>	ACVS101 Foam Insulation See section E for more details	1	pack	VS010 VS011 VS112	MF	
					SA	
					KL	
					HP	
					M	
					GOZ	
					W	
					Z	
					PC	
	ACVS123 VS123 End Caps	10	pairs		MF	
					SA	
					KL	
					HP	
					M	
					GOZ	
					W	✓
					Z	✓
					PC	
	ACVS124 VS124 End Caps	10	sets		MF	
					SA	
					KL	
					HP	
					M	
					GOZ	
					W	✓
					Z	✓
					PC	
 <p>T-BARS ACVG65=2.5mm ACVG66=3.0mm ACVL150=4.0mm</p>	 <p>Screw (Grub)</p>	MF = Mill Finish SA = Silver Anodised KL = Basic Colour HP = Special Colour M = Dual Colour		GOZ = Gold PC = Polished Chrome W = White Z = Black		
						

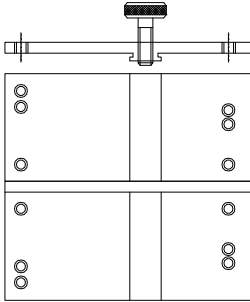
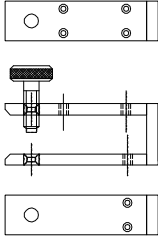


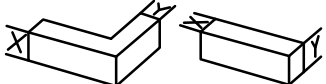
Image	Part Code	Pack	Unit	Application	Colour
	ACVS901 Outerframe Drill Jig	1	each		MF
					SA
					KL
					HP
					M
					GOZ
					W
					Z
					PC
					
SA					
KL					
HP					
M					
GOZ					
W					
Z					
PC					
					SA
					KL
					HP
					M
					GOZ
					W
					Z
					PC
					MF
					SA
					KL
					HP
					M
					GOZ
					W
					Z
					PC
		MF = Mill Finish SA = Silver Anodised KL = Basic Colour HP = Special Colour M = Dual Colour		GOZ = Gold PC = Polished Chrome W = White Z = Black	
					






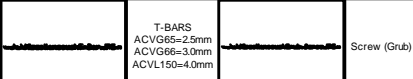
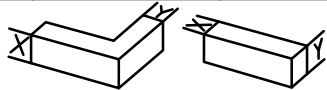



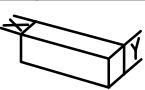
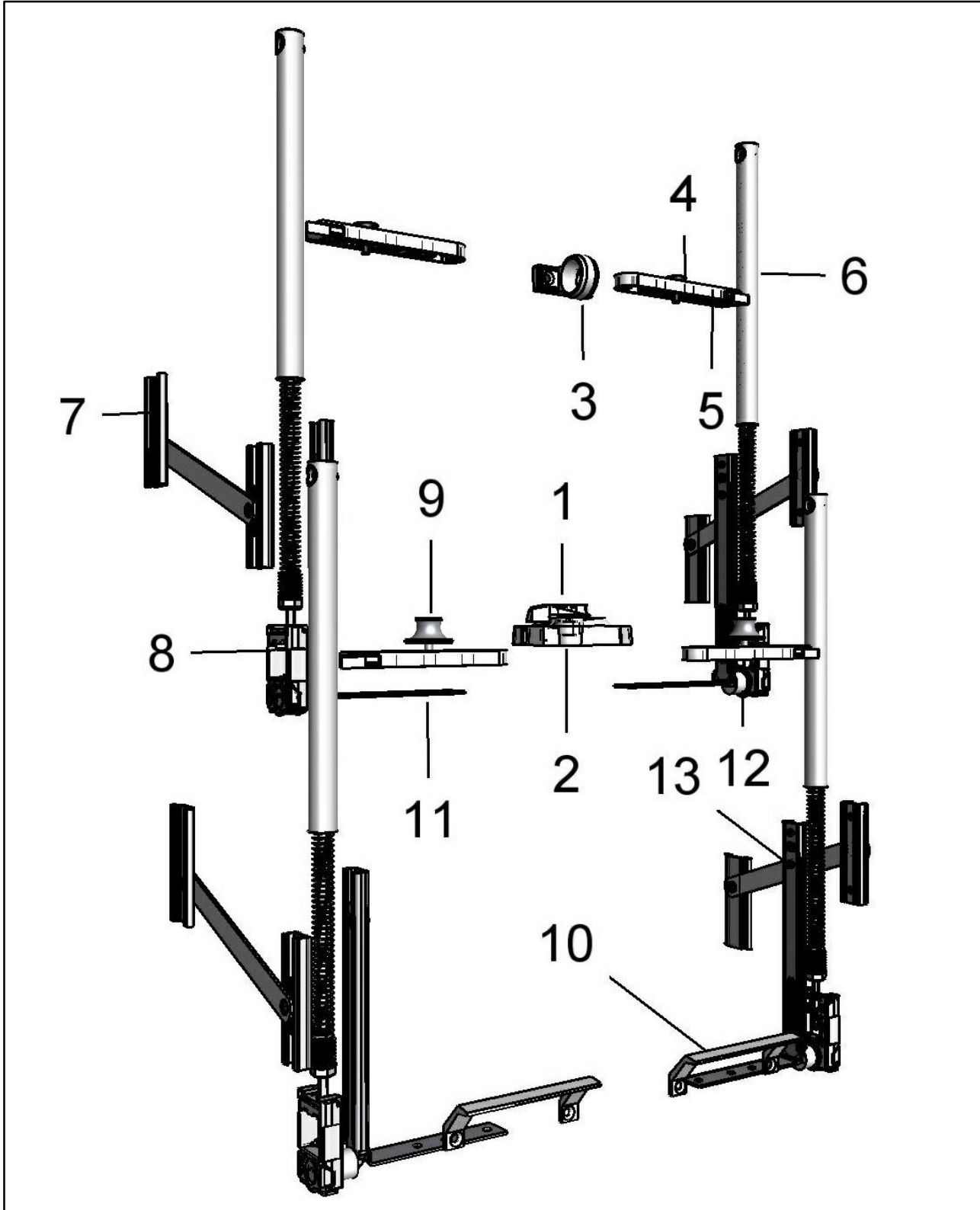
Image	Part Code	Pack	Unit	Application	Colour
	ACMX09700 Alu. Polish	1	each		MF ✓ SA KL HP M GOZ W Z
	ACMX09761 Maxi Gloss	1	each		MF SA KL HP M GOZ W Z
	ACMX09762 Alu. Bright	1	each		MF SA KL HP M GOZ W Z
	ACMX09763 Teflon Spray	1	each		MF SA KL HP M GOZ W Z
	ACMX09764 Maxi Clean	1	each		MF SA KL HP M GOZ W Z
	T-BARS ACVG65=2.5mm ACVG66=3.0mm ACVL150=4.0mm Screw (Grub)				
	MF = Mill Finish SA = Silver Anodised KL = Basic Colour HP = Special Colour				M = Dual Colour GOZ = Gold W = White Z = Black
					

Image	Part Code	Pack	Unit	Application	Colour
	ACMX09765 Alu. Cleaner	1	each		MF SA KL HP M GOZ W Z
	ACMX09770 Roll & Wrap 100mm	1	each		MF SA KL HP M GOZ W Z
	ACMX09775 Grip Handwrap	1	each		MF SA KL HP M GOZ W Z
	ACMX09801 Protective Tape 50mm	1	each		MF SA KL HP M GOZ W Z
	ACMX09802 Protective Tape 70mm	1	each		MF SA KL HP M GOZ W Z
 <p>T-BARS ACVG65=2.5mm ACVG66=3.0mm ACVL150=4.0mm</p>  <p>Screw (Grub)</p>	<p>MF = Mill Finish SA = Silver Anodised KL = Basic Colour HP = Special Colour</p> <p>M = Dual Colour GOZ = Gold W = White Z = Black</p>				

Image	Part Code	Pack	Unit	Application	Colour																
	ACMX09803 Protective Tape 100mm	1	each		<table border="1"> <tr><td>MF</td><td></td></tr> <tr><td>SA</td><td></td></tr> <tr><td>KL</td><td></td></tr> <tr><td>HP</td><td></td></tr> <tr><td>M</td><td></td></tr> <tr><td>GOZ</td><td></td></tr> <tr><td>W</td><td></td></tr> <tr><td>Z</td><td></td></tr> </table>	MF		SA		KL		HP		M		GOZ		W		Z	
MF																					
SA																					
KL																					
HP																					
M																					
GOZ																					
W																					
Z																					
	ACMX09830 Rubber Sealant	1	each		<table border="1"> <tr><td>MF</td><td></td></tr> <tr><td>SA</td><td></td></tr> <tr><td>KL</td><td></td></tr> <tr><td>HP</td><td></td></tr> <tr><td>M</td><td></td></tr> <tr><td>GOZ</td><td></td></tr> <tr><td>W</td><td></td></tr> <tr><td>Z</td><td></td></tr> </table>	MF		SA		KL		HP		M		GOZ		W		Z	
MF																					
SA																					
KL																					
HP																					
M																					
GOZ																					
W																					
Z																					
	ACSIL04 Sealing Glue	1	each		<table border="1"> <tr><td>MF</td><td></td></tr> <tr><td>SA</td><td></td></tr> <tr><td>KL</td><td></td></tr> <tr><td>HP</td><td></td></tr> <tr><td>M</td><td></td></tr> <tr><td>GOZ</td><td></td></tr> <tr><td>W</td><td>✓</td></tr> <tr><td>Z</td><td>✓</td></tr> </table>	MF		SA		KL		HP		M		GOZ		W	✓	Z	✓
MF																					
SA																					
KL																					
HP																					
M																					
GOZ																					
W	✓																				
Z	✓																				
	ACSIL08 Silicon Gun	1	each		<table border="1"> <tr><td>MF</td><td></td></tr> <tr><td>SA</td><td></td></tr> <tr><td>KL</td><td></td></tr> <tr><td>HP</td><td></td></tr> <tr><td>M</td><td></td></tr> <tr><td>GOZ</td><td></td></tr> <tr><td>W</td><td></td></tr> <tr><td>Z</td><td></td></tr> </table>	MF		SA		KL		HP		M		GOZ		W		Z	
MF																					
SA																					
KL																					
HP																					
M																					
GOZ																					
W																					
Z																					
	ACSIL013 Glue for Mitre	1	each		<table border="1"> <tr><td>MF</td><td></td></tr> <tr><td>SA</td><td></td></tr> <tr><td>KL</td><td></td></tr> <tr><td>HP</td><td></td></tr> <tr><td>M</td><td></td></tr> <tr><td>GOZ</td><td></td></tr> <tr><td>W</td><td></td></tr> <tr><td>Z</td><td></td></tr> </table>	MF		SA		KL		HP		M		GOZ		W		Z	
MF																					
SA																					
KL																					
HP																					
M																					
GOZ																					
W																					
Z																					
<table border="1"> <tr> <td></td> <td>T-BARS ACVG65=2.5mm ACVG66=3.0mm ACVL150=4.0mm</td> <td></td> <td>Screw (Grub)</td> </tr> </table>		T-BARS ACVG65=2.5mm ACVG66=3.0mm ACVL150=4.0mm		Screw (Grub)	MF = Mill Finish SA = Silver Anodised KL = Basic Colour HP = Special Colour	M = Dual Colour GOZ = Gold W = White Z = Black															
	T-BARS ACVG65=2.5mm ACVG66=3.0mm ACVL150=4.0mm		Screw (Grub)																		

Image	Part Code	Pack	Unit	Application	Colour
					MF
					SA
					KL
					HP
					M
					GOZ
					W
					Z
					MF
					SA
					KL
					HP
					M
					GOZ
					W
					Z
					MF
					SA
					KL
					HP
					M
					GOZ
					W
					Z
					MF
					SA
					KL
					HP
					M
					GOZ
					W
					Z
 T-BARS ACVG65=2.5mm ACVG66=3.0mm ACVL150=4.0mm	 Screw (Grub)	MF = Mill Finish SA = Silver Anodised KL = Basic Colour HP = Special Colour		M = Dual Colour GOZ = Gold W = White Z = Black	
		 			

**The following hardware
to be purchased directly
from Caldwell Hardware
(UK) Ltd
sales@caldwell.co.uk
024 7643 7900**



- 1. KL800 Sash Lock - NL800 Non-Locking Version
- 2. 30459 Sash Lock Keep
- 3. UK624 Pole Ring
- 4. UK833 Tilt Catch Knob
- 5. UK478 Tilt Latch
- 6. Balances- Ultrafit Torso
- 7. Bar Tilt Restrictor

- 8. PE739 Pivot Shoe
- 9. UK545 Tilt Latch Knob
- 10. 8790 Sash Lift Hook
- 11. UK526 Pivot Bar Carrier
- 12. UK507 Pivot Bar and Shackle
- 13. UK469 Rivet

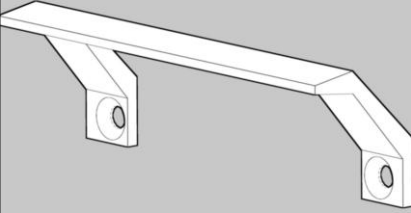
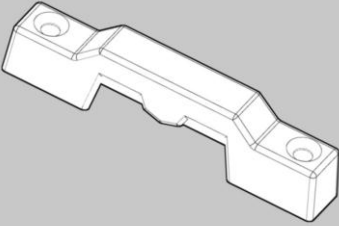
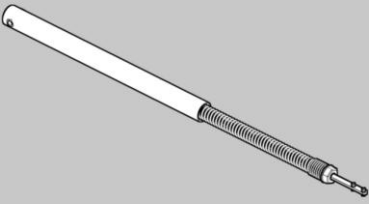
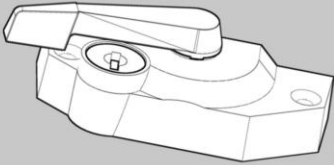
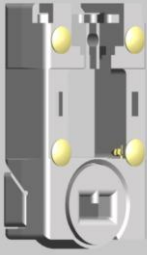


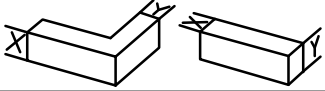
Image	Part Code	Pack	Unit	Application	Colour
	8790 Sash Lift Hook	1	each	This hardware is only available direct from Caldwell	MF
					BS
					KL
					HP
					M
					GOZ
					W
					Z
					PC
	30459 Sash Lock Keep	1	each	This hardware is only available direct from Caldwell	MF
					BS
					KL
					HP
					M
					GOZ
					W
					Z
					PC
	Ultralift Torso Balance Part of Balance Kit			This hardware is only available direct from Caldwell	MF
					SA
					KL
					HP
					M
					GOZ
					W
					Z
					PC
	KL800 Sash Lock (Non-Locking ref: NL800)	1	each	This hardware is only available direct from Caldwell	MF
					BS
					KL
					HP
					M
					GOZ
					W
					Z
					PC
	PE739 Pivot Shoe Part of Balance Kit			This hardware is only available direct from Caldwell	MF
					SA
					KL
					HP
					M
					GOZ
					W
					Z
					PC
 T-BARS ACVG65=2.5mm ACVG66=3.0mm ACVL150=4.0mm	 Screw (Grub)	MF = Mill Finish BS = Brushed Steel KL = Basic Colour HP = Special Colour M = Dual Colour		GOZ = Gold PC = Polished Chrome W = White Z = Black	
					

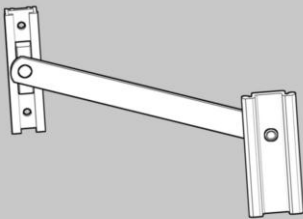
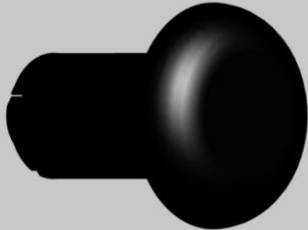
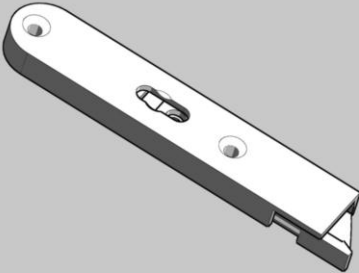

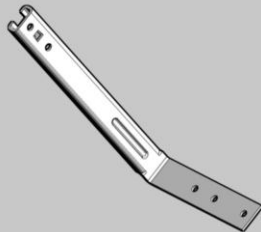


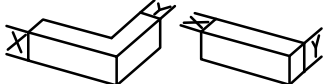
Image	Part Code	Pack	Unit	Application	Colour	
	RA150RUQR RA250RUQR RA350RUQR Bar Tilt restrictor	1	each	This hardware is only available direct from Caldwell	MF	
					BS	✓
					KL	
					HP	
					M	
					GOZ	✓
					W	✓
					Z	✓
					PC	✓
	UK469 Plastic Rivet Part of Balance Kit			This hardware is only available direct from Caldwell	MF	
					SA	
					KL	
					HP	
					M	
					GOZ	
					W	
					Z	
					PC	
	UK472L/R Tilt Latch Part of Balance Kit			This hardware is only available direct from Caldwell	MF	
					SA	
					KL	
					HP	
					M	
					GOZ	
					W	
					Z	
					PC	
	UK507 Pivot Bar and Shackle Part of Balance Kit			This hardware is only available direct from Caldwell	MF	
					SA	
					KL	
					HP	
					M	
					GOZ	
					W	
					Z	
					PC	
	UK526 Pivot Bar carrier Part of Balance Kit			This hardware is only available direct from Caldwell	MF	
					SA	
					KL	
					HP	
					M	
					GOZ	
					W	
					Z	
					PC	
 T-BARS ACVG65=2.5mm ACVG66=3.0mm ACVL150=4.0mm	 Screw (Grub)	MF = Mill Finish BS = Brushed Steel KL = Basic Colour HP = Special Colour M = Dual Colour		GOZ = Gold PC = Polished Chrome W = White Z = Black		


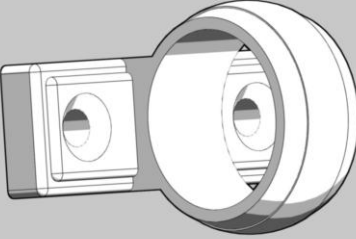

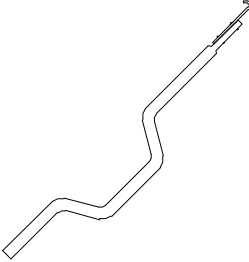


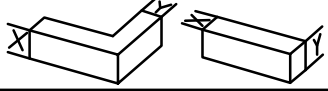
Image	Part Code	Pack	Unit	Application	Colour		
	UK545 Tilt Latch Knob	1	each	This hardware is only available direct from Caldwell	MF		
					BS	✓	
					KL		
					HP		
					M		
					GOZ	✓	
					W	✓	
					Z	✓	
					PC	✓	
	UK624 Pole Ring	1	each	This hardware is only available direct from Caldwell	MF		
					BS	✓	
					KL		
					HP		
					M		
					GOZ	✓	
					W	✓	
					Z	✓	
					PC	✓	
	UK858 Tilt Latch Knob	1	each	This hardware is only available direct from Caldwell	MF		
					SA		
					KL		
					HP		
					M		
					GOZ		
					W		
					Z		
					PC		
	ATW-TEN Tilting Sash Tensioning Tool	1	each	This hardware is only available direct from Caldwell	MF		
					SA		
					KL		
					HP		
					M		
					GOZ		
					W		
					Z		
					PC		
 	MF = Mill Finish BS = Brushed Steel KL = Basic Colour HP = Special Colour M = Dual Colour						
							GOZ = Gold PC = Polished Chrome W = White Z = Black
							



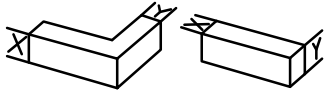

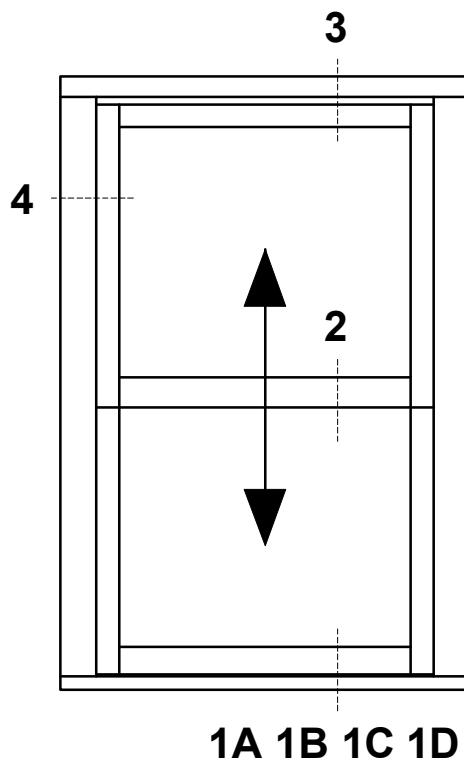
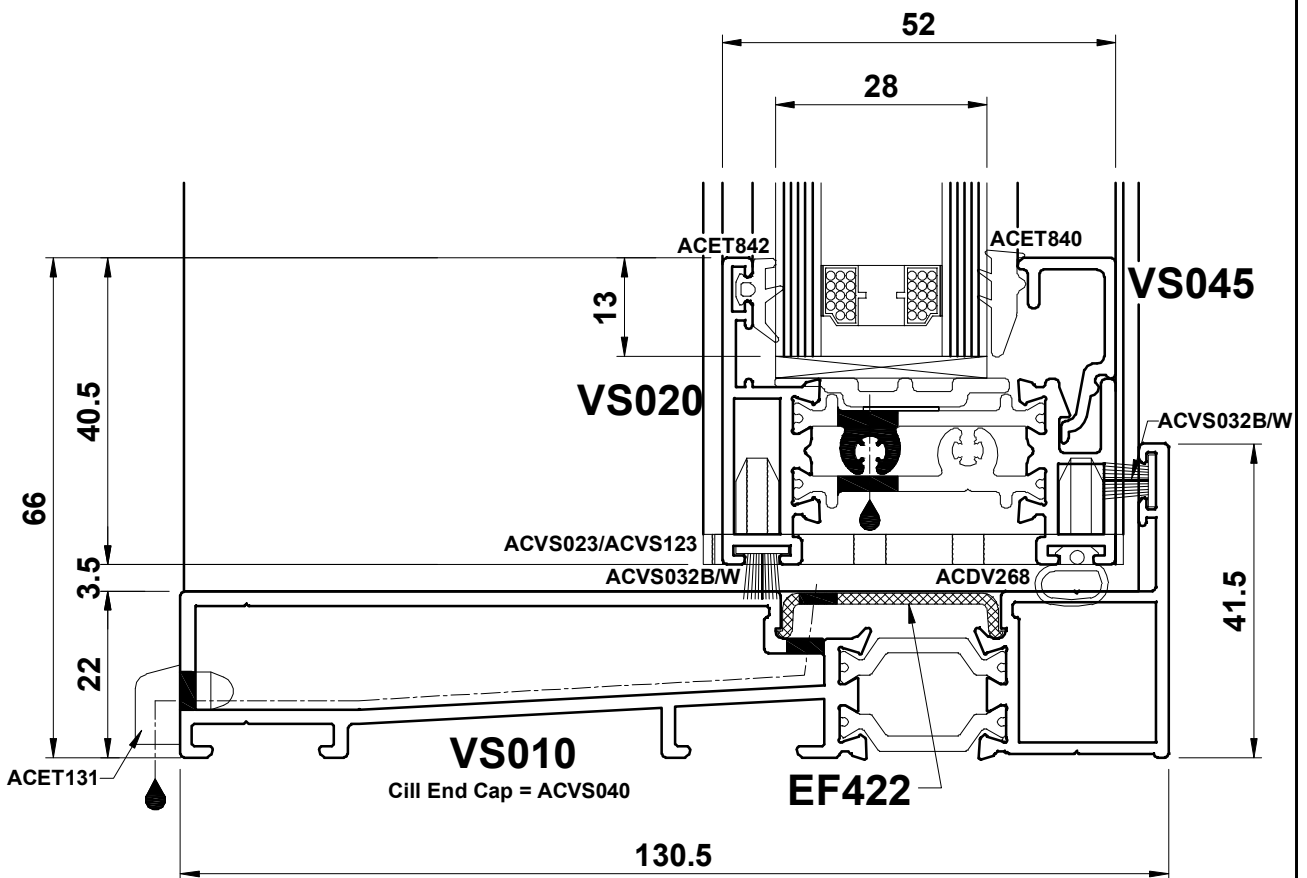
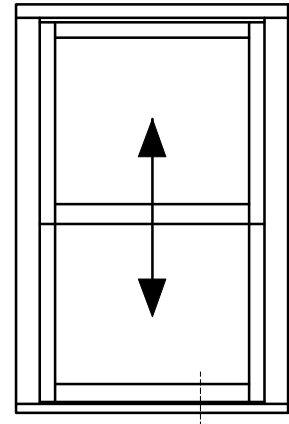
Image	Part Code	Pack	Unit	Application	Colour
					MF
					BS
					KL
					HP
					M
					GOZ
					W
					Z
					PC
					MF
					BS
					KL
					HP
					M
					GOZ
					W
					Z
					PC
					MF
					SA
					KL
					HP
					M
					GOZ
					W
					Z
					PC
					MF
					SA
					KL
					HP
					M
					GOZ
					W
					Z
					PC
 <p>T-BARS ACVG65=2.5mm ACVG66=3.0mm ACVL150=4.0mm</p>	 <p>Screw (Grub)</p>	<p>MF = Mill Finish BS = Brushed Steel KL = Basic Colour HP = Special Colour M = Dual Colour</p> <p>GOZ = Gold PC = Polished Chrome W = White Z = Black</p>			

Image	Part Code	Pack	Unit	Application	Colour
					MF
					BS
					KL
					HP
					M
					GOZ
					W
					Z
					PC
BS					
KL					
HP					
M					
GOZ					
W					
Z					
PC					
					SA
					KL
					HP
					M
					GOZ
					W
					Z
					PC
SA					
KL					
HP					
M					
GOZ					
W					
Z					
PC					
					SA
					KL
					HP
					M
					GOZ
					W
					Z
					PC
					 <p>T-BARS ACVG65=2.5mm ACVG66=3.0mm ACVL150=4.0mm</p>

Section C

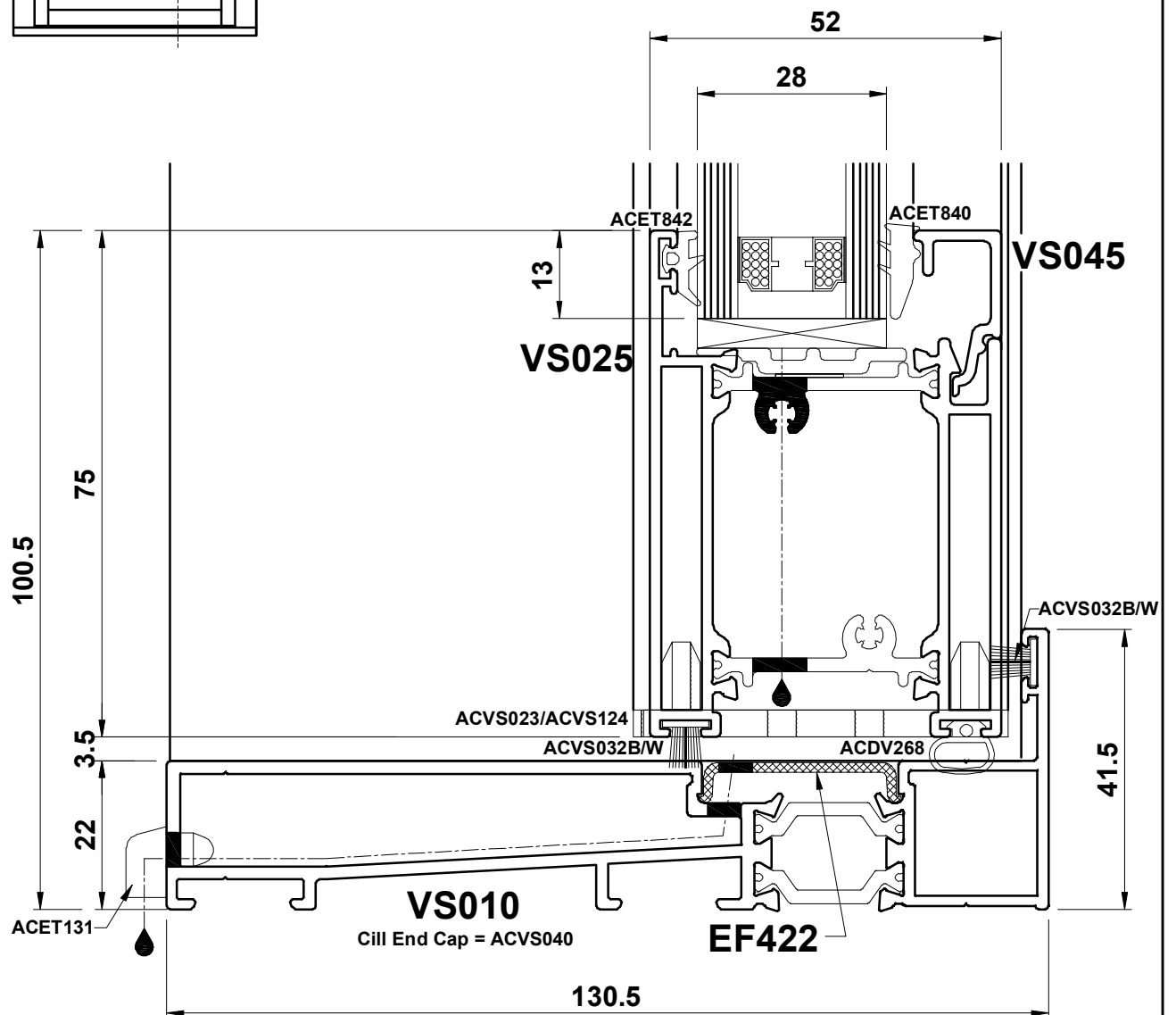
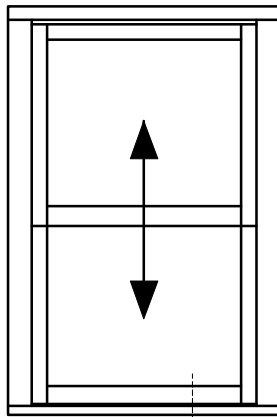


Detail 1A



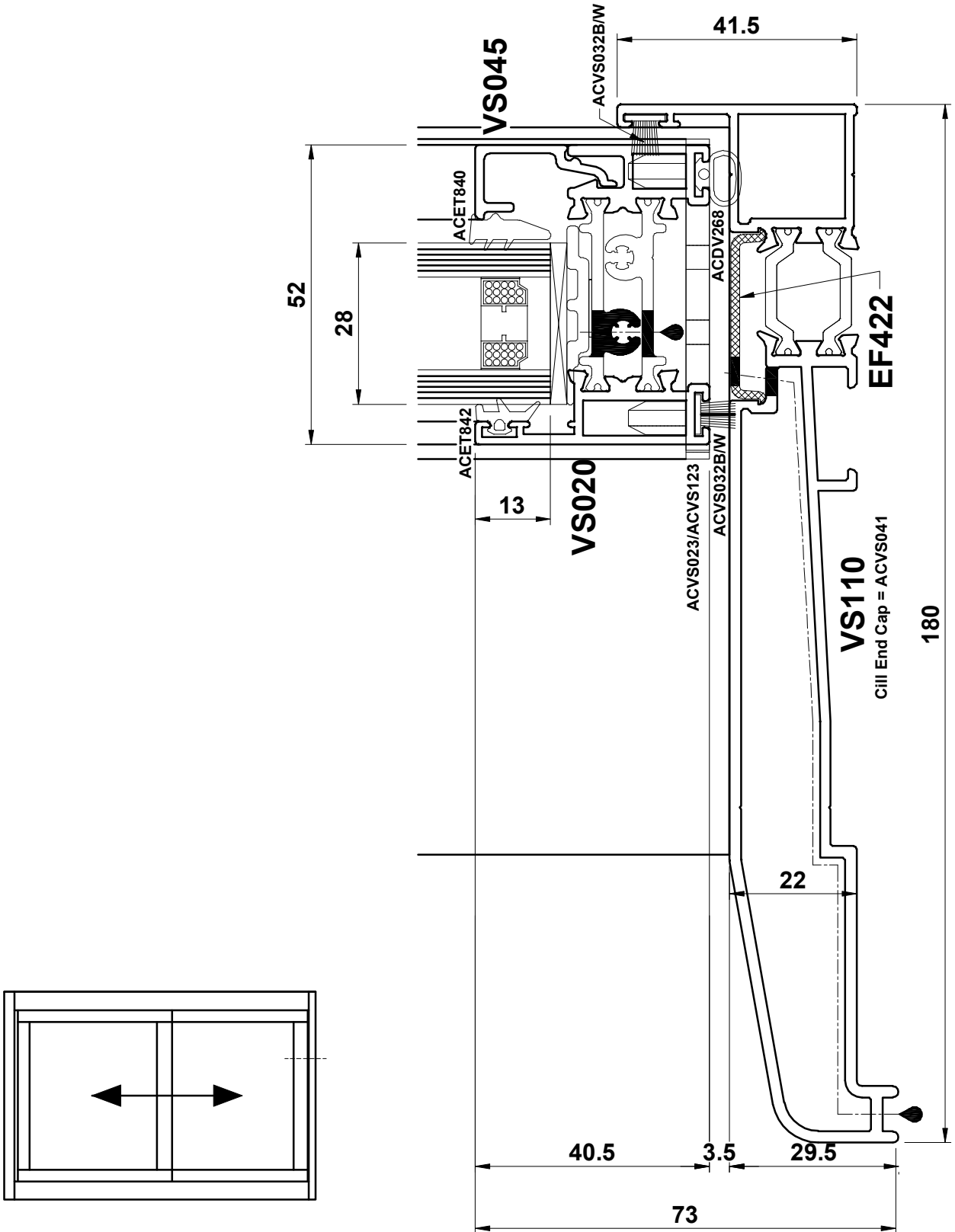
Do Not Scale From This Drawing

Detail 1B



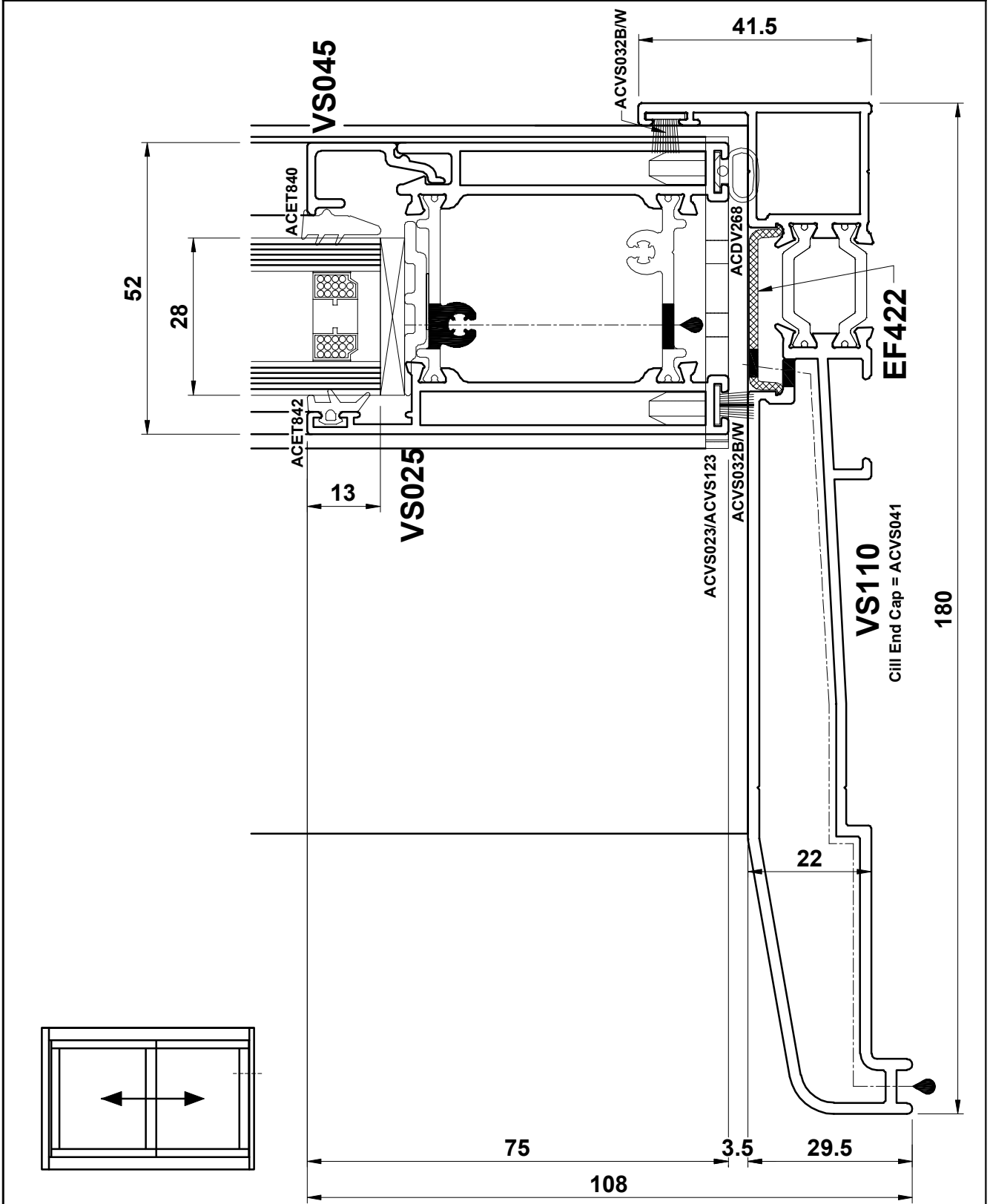
Do Not Scale From This Drawing

Detail 1C



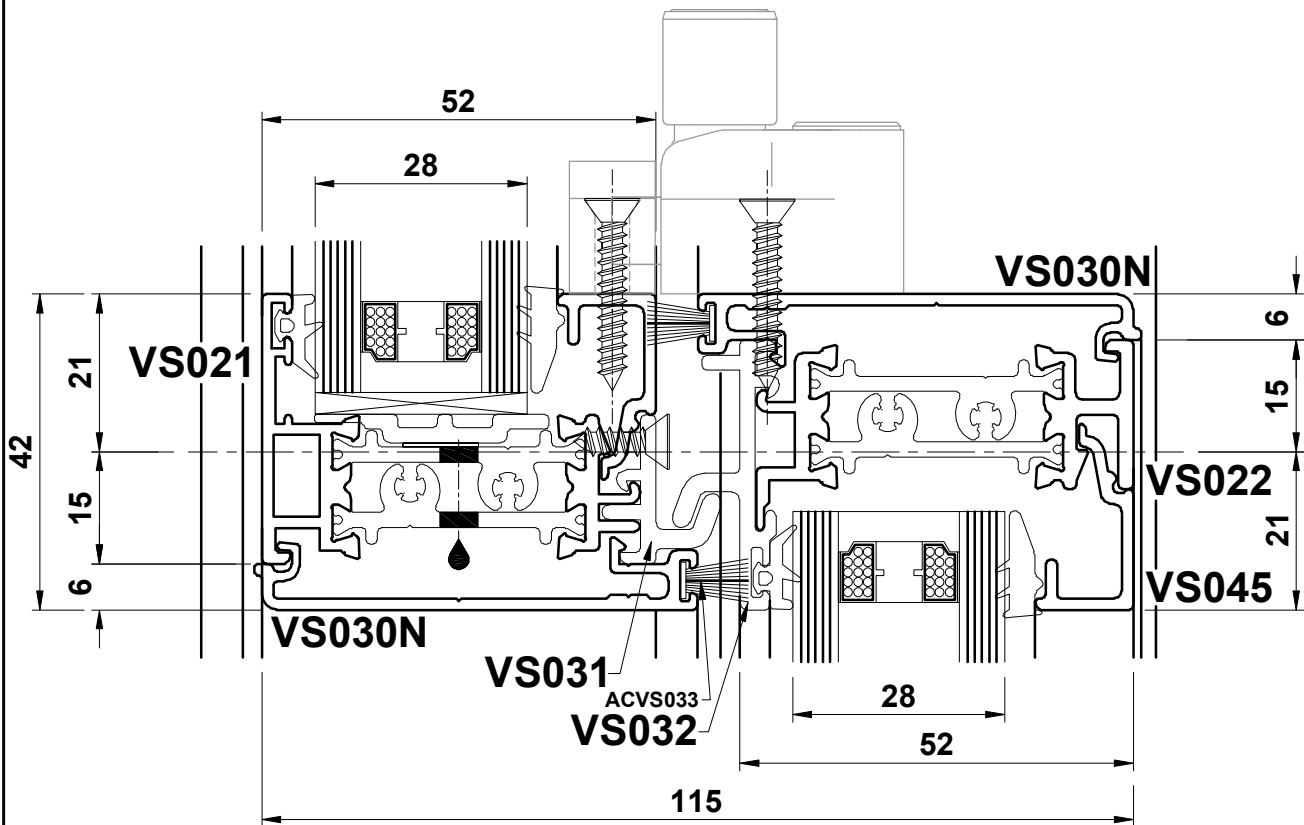
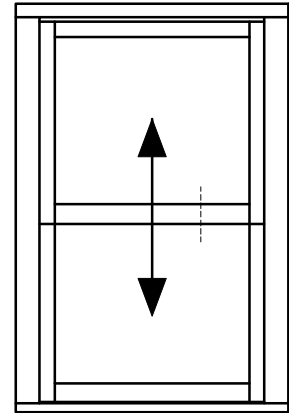
Do Not Scale From This Drawing

Detail 1D



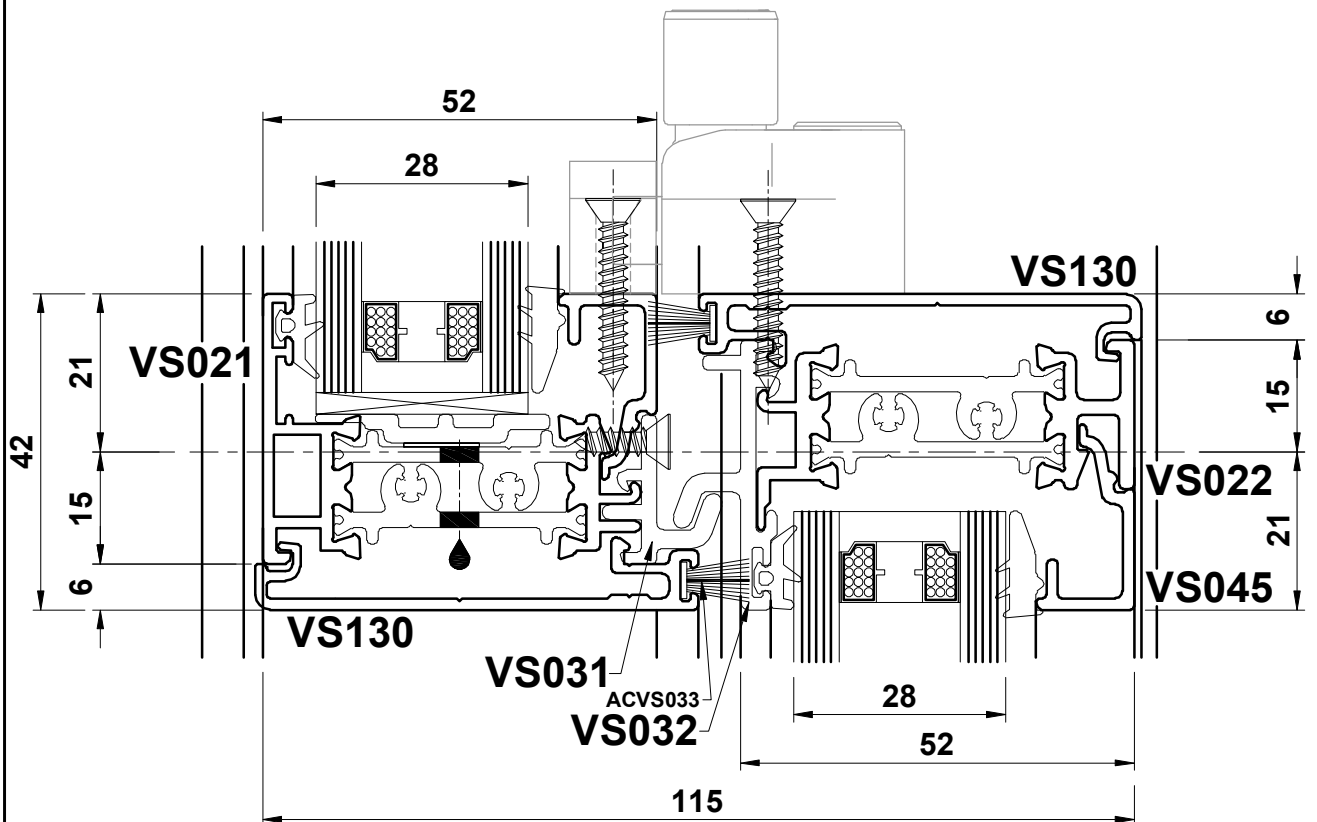
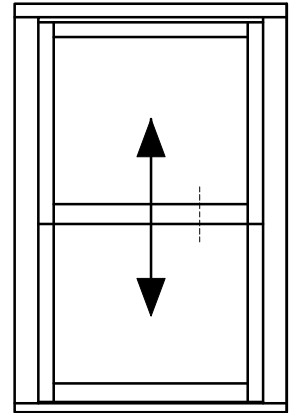
Do Not Scale From This Drawing

Detail 2A



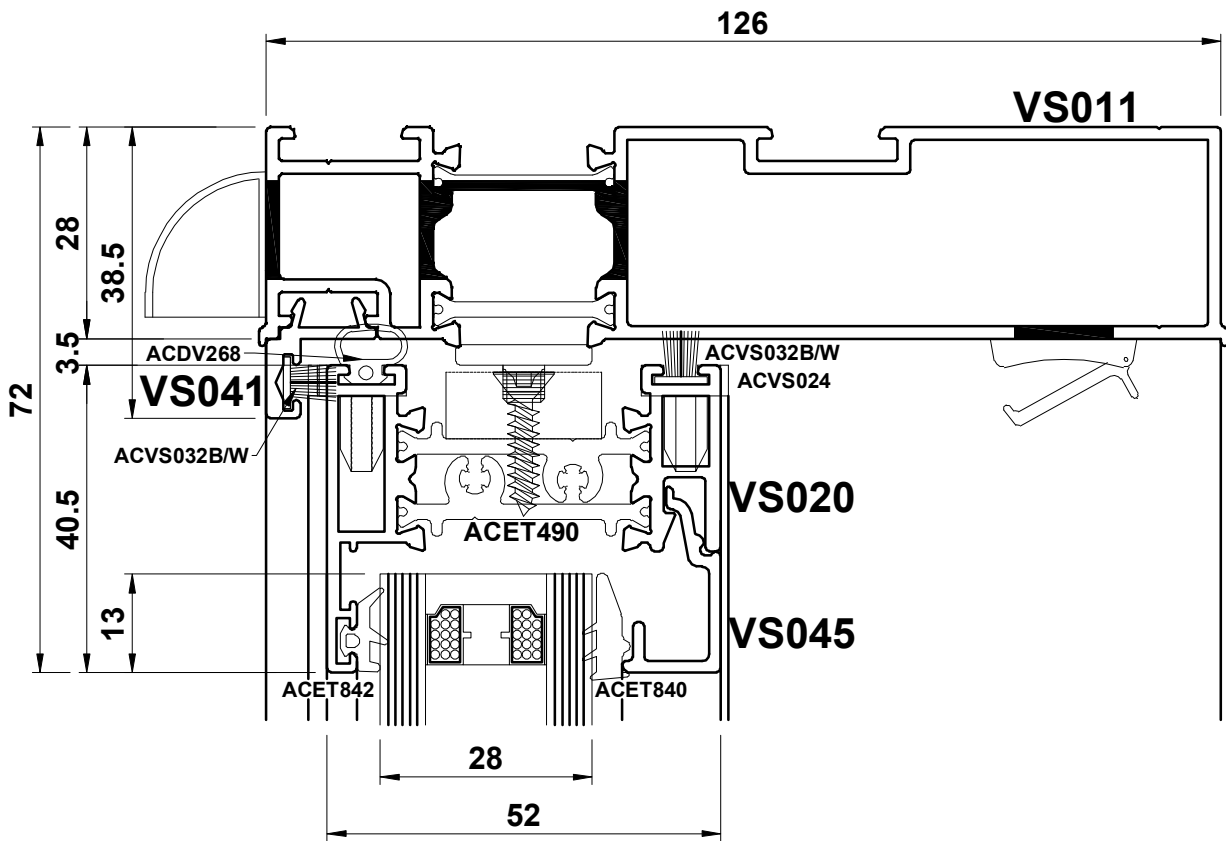
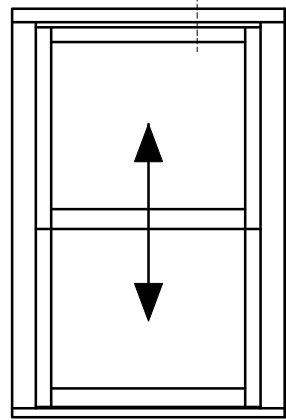
Do Not Scale From This Drawing

Detail 2B



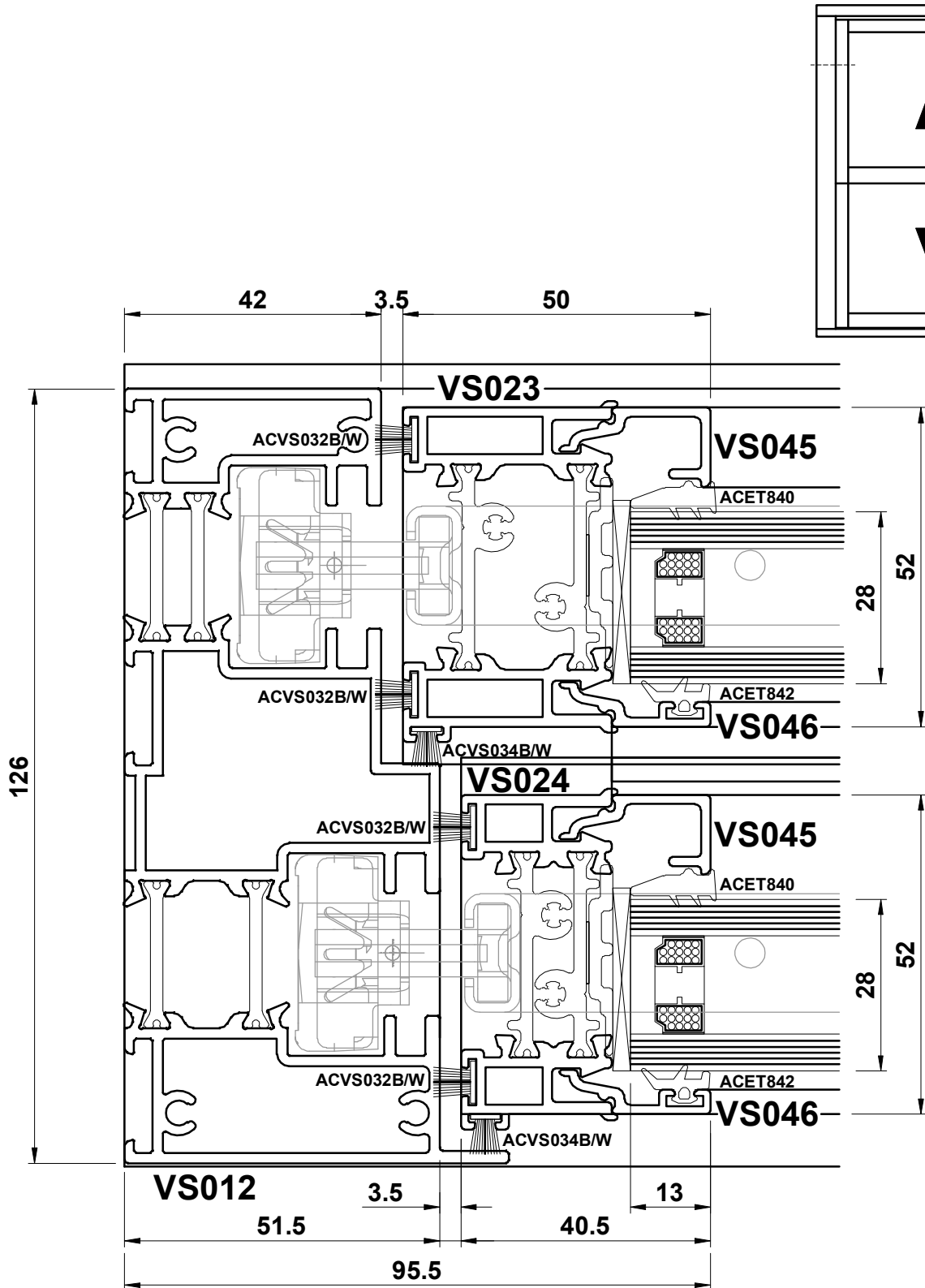
Do Not Scale From This Drawing

Detail 3



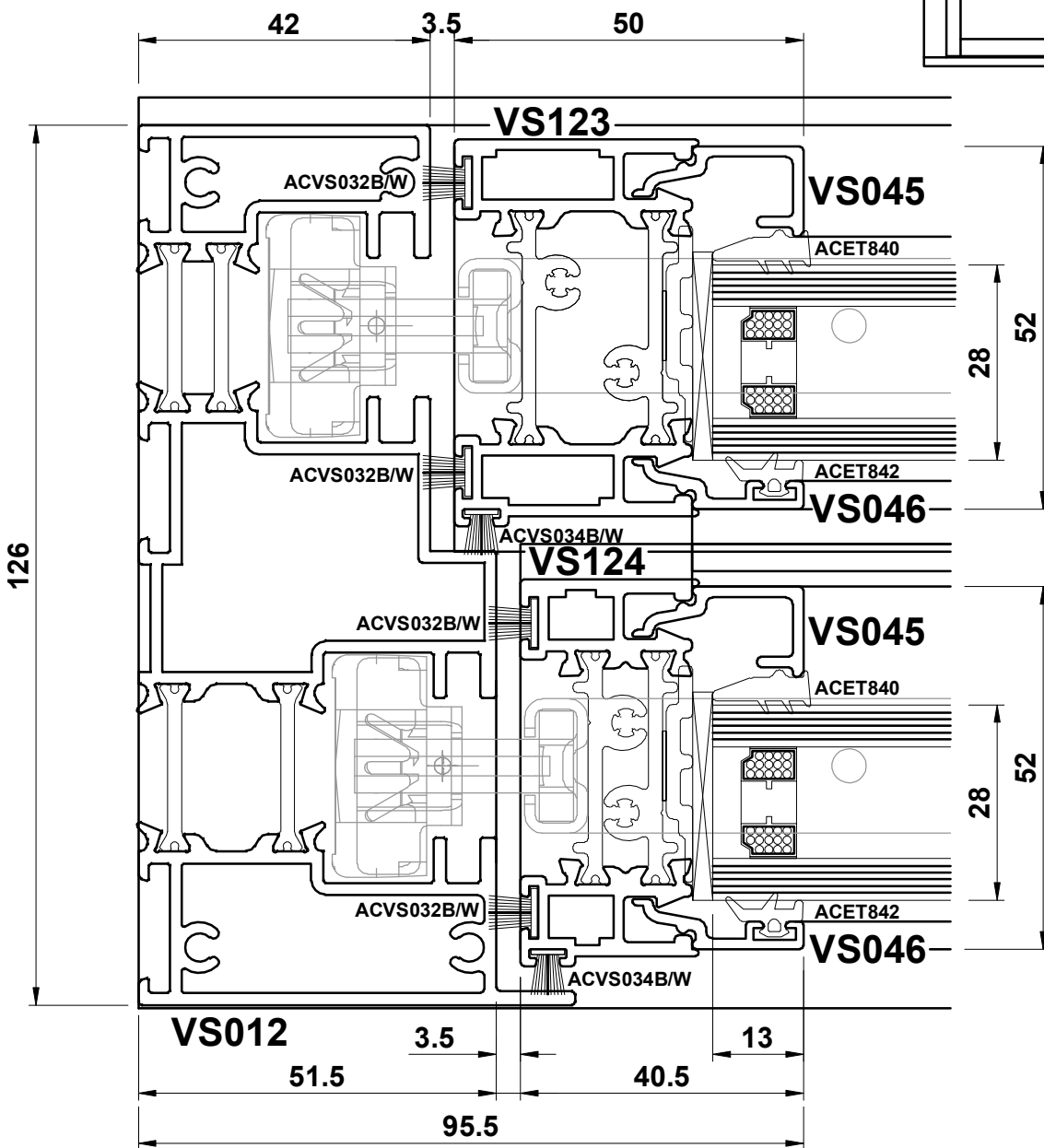
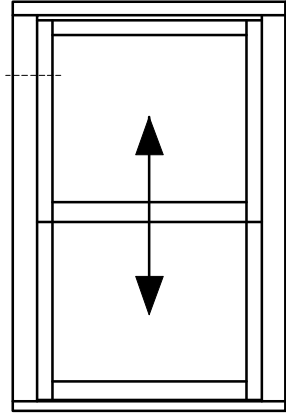
Do Not Scale From This Drawing

Detail 4A



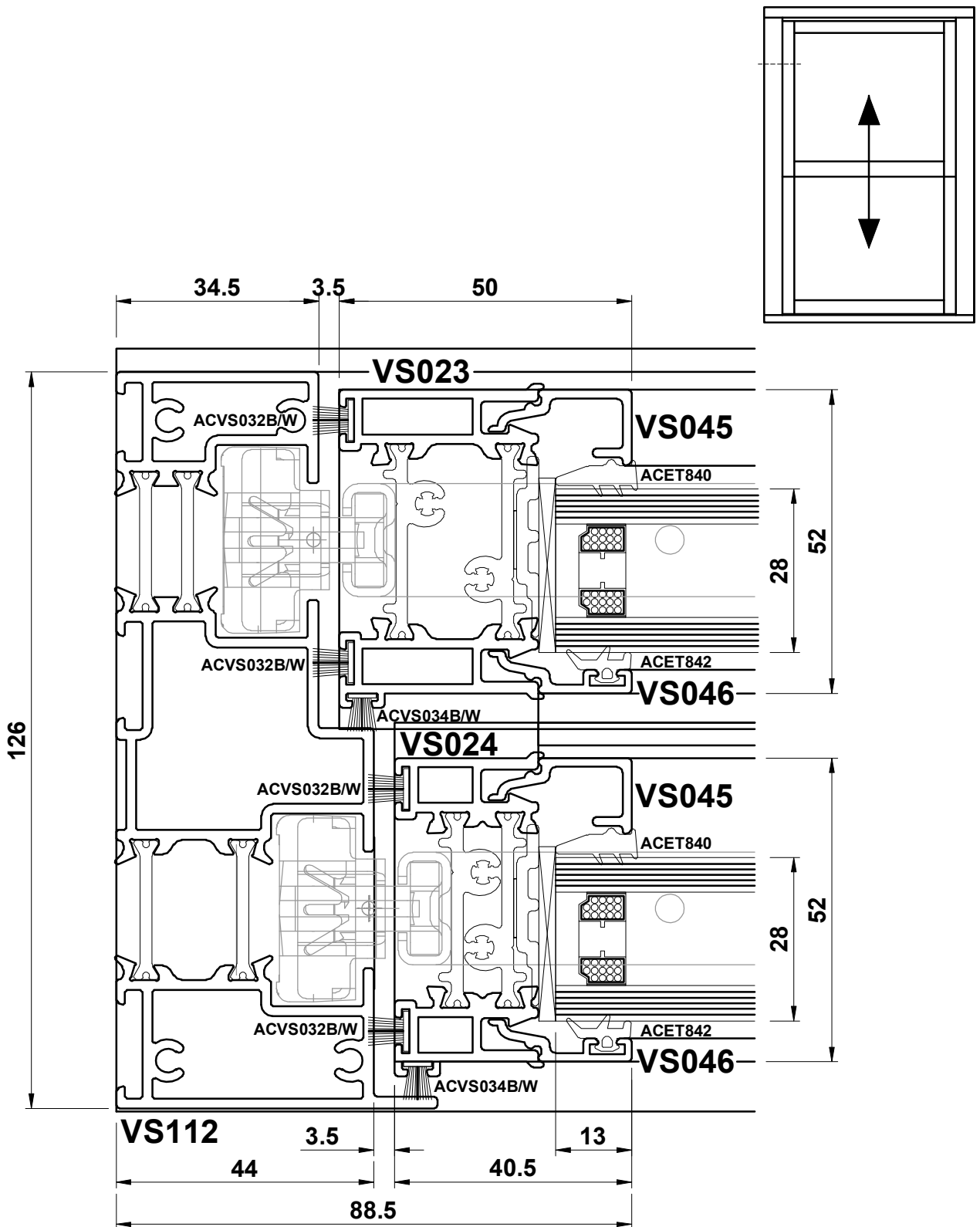
Do Not Scale From This Drawing

Detail 4B



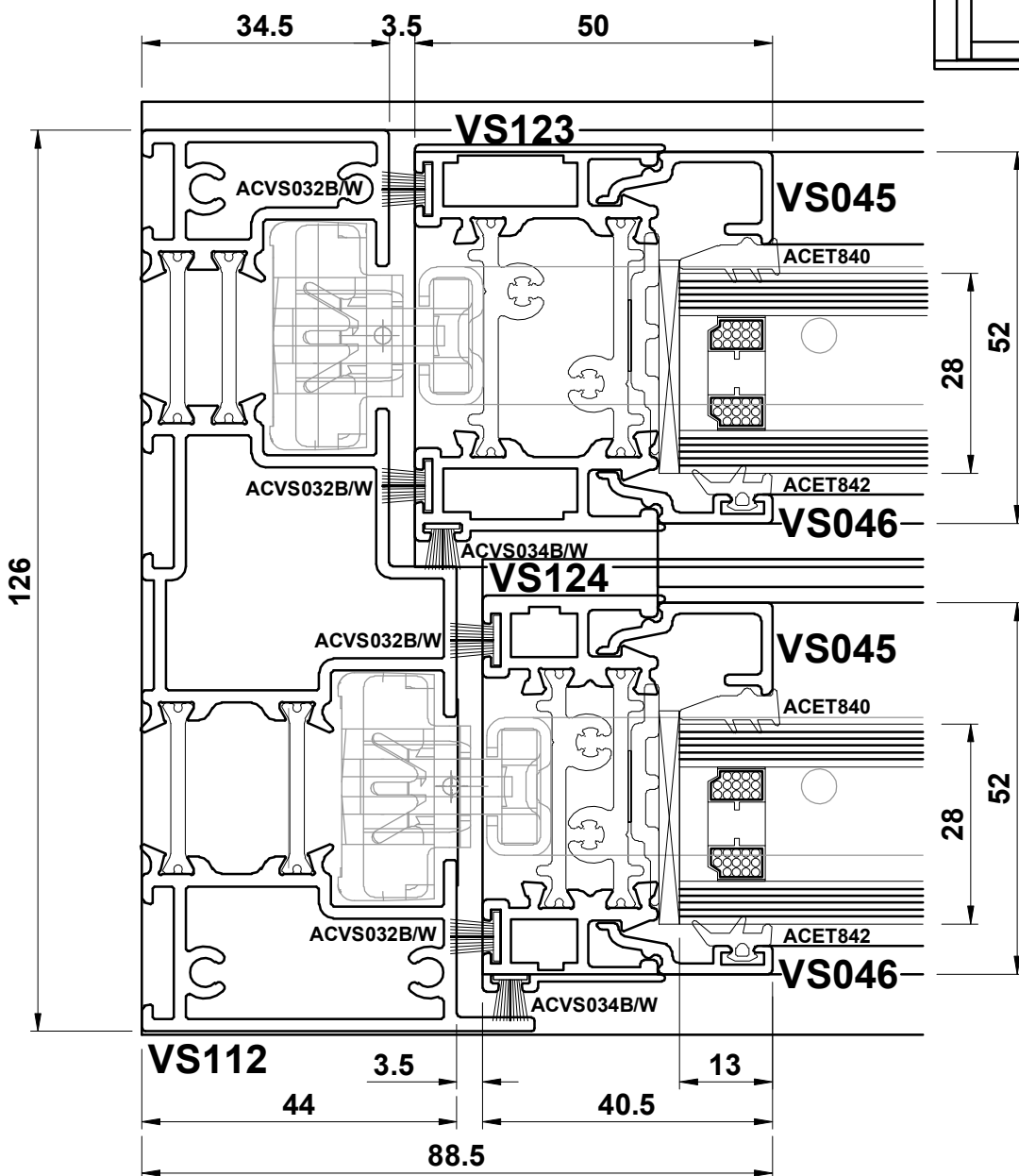
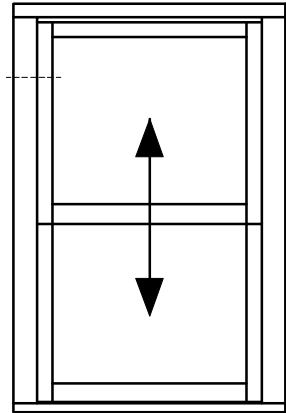
Do Not Scale From This Drawing

Detail 4C



Do Not Scale From This Drawing

Detail 4D



Do Not Scale From This Drawing

Section D

Section D

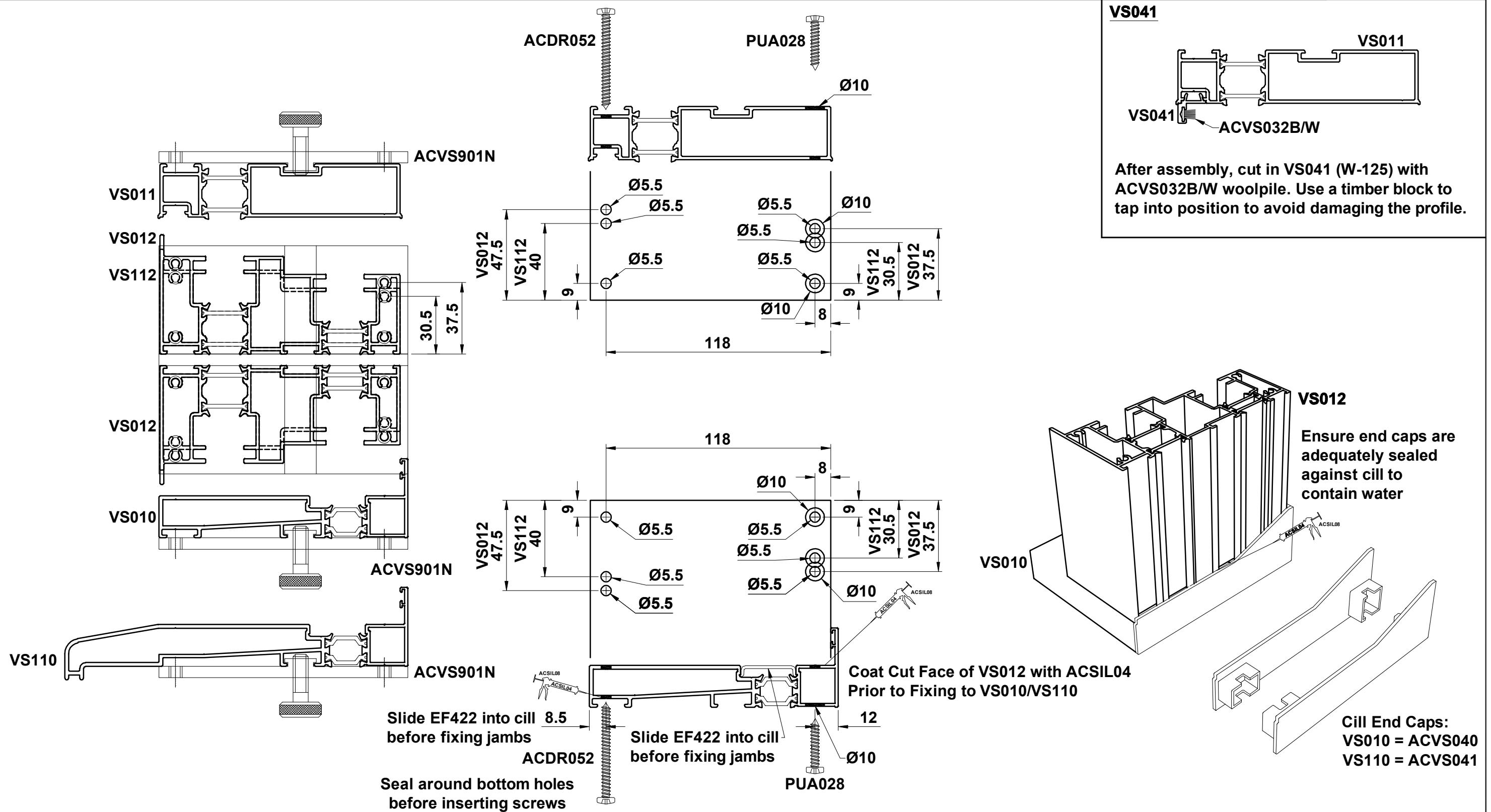
Section E



Construction Drawings

Outer Frame Assembly.....	Page E02
Drainage	Page E03
Attaching Spring Balances and Travel Stops.....	Page E04-E05
Bottom Sash Assembly	Page E06
Top Sash Assembly.....	Page E07
Pivot Bar Carrier Fitting	Page E08
Release Catch Fitting and Interlock Preparation.....	Page E09
Bar Tilt Restrictor Fitting	Page E10
Sash Lock and Keep	Page E11
Lifting Hooks and Pole Ring Fitting.....	Page E12
Sash Insertion	Page E13
Coupling and ACVL130 Fixing Lug	Page E14
ACVS100 Foam Location	Page E15
Georgian Bar Information	Page E16

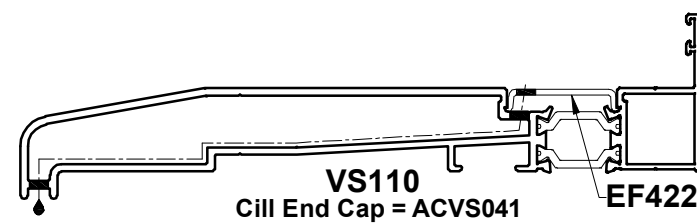
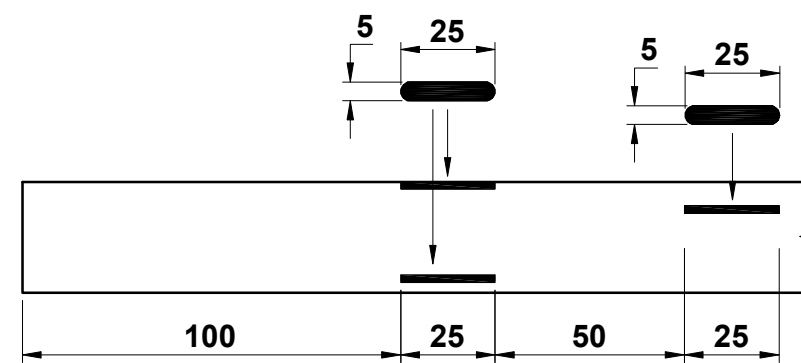
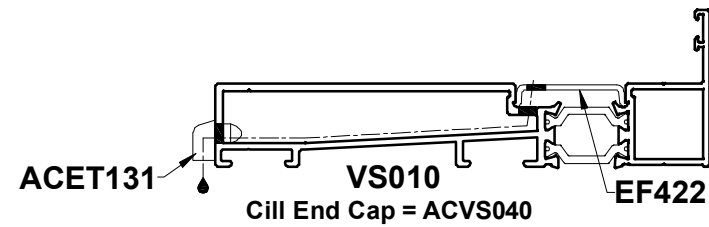
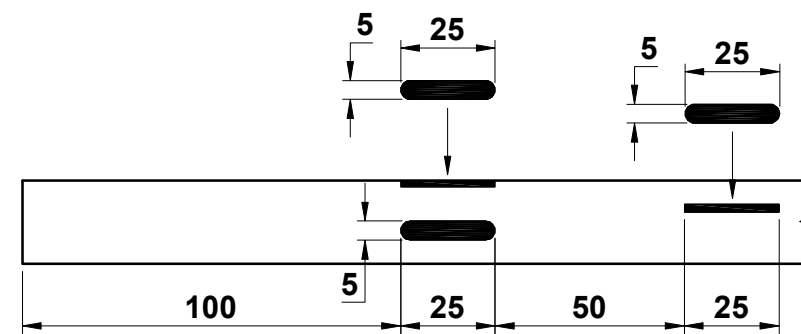
Outer Frame Assembly



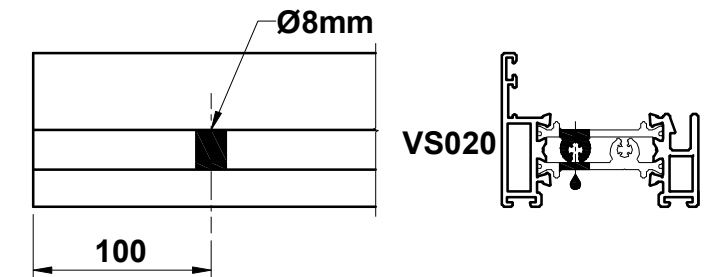
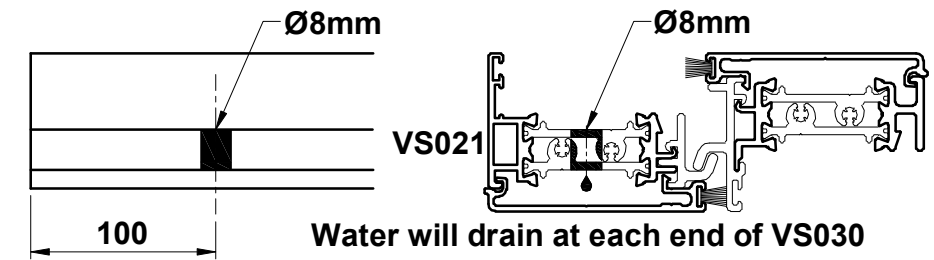
Do Not Scale From This Drawing

Drainage

Outer Frame Drainage



Sash Drainage

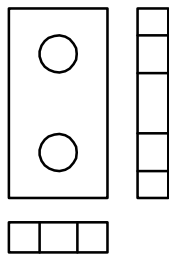


Do Not Scale From This Drawing

Attaching Spring Balances & Fitting Travel Stops

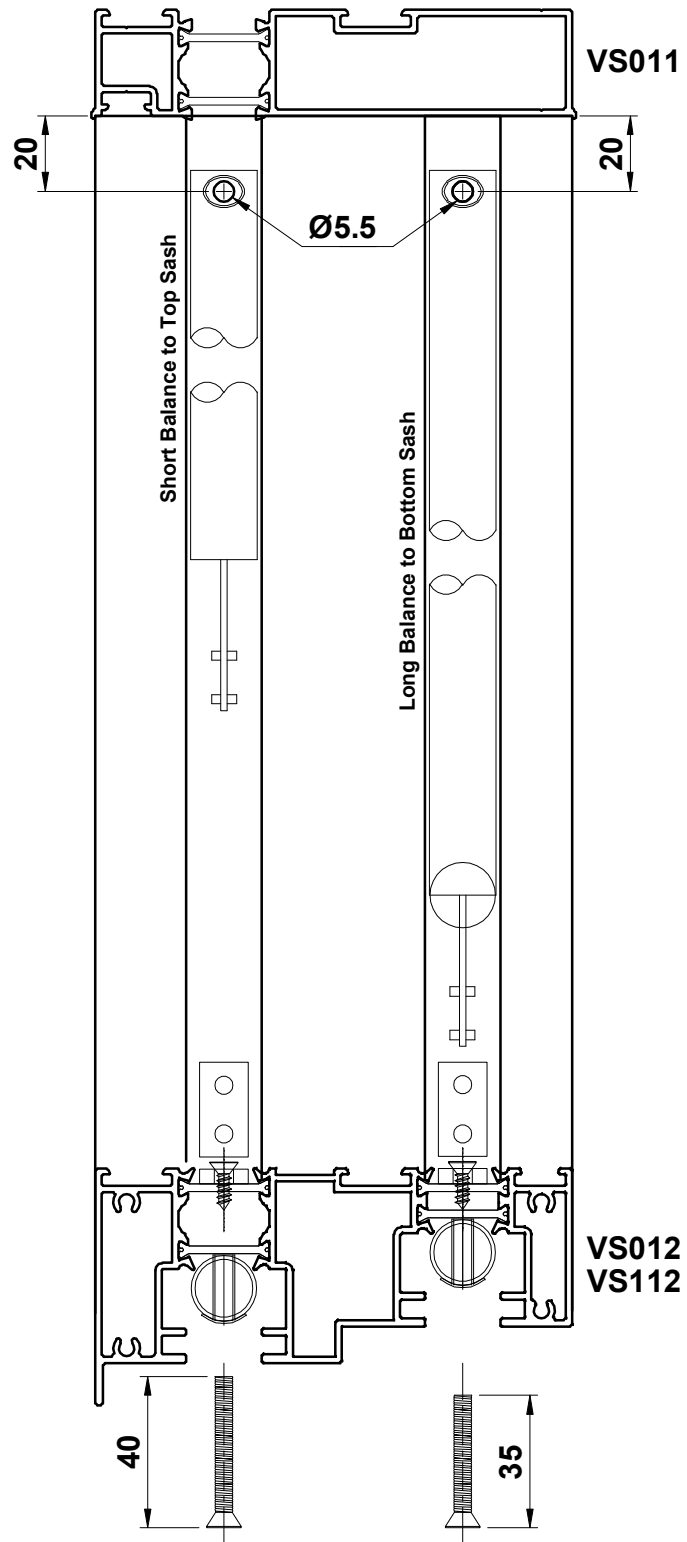
Step One:

Drill 2 x Ø5.5mm holes as shown and use fixing plates and machine screws from ACVS042 to secure the balances in both jambs. Once secured, secure the fixing plate in position using the self tapping screws. This will secure the plates for future maintenance.



ACVS042 Kit includes:

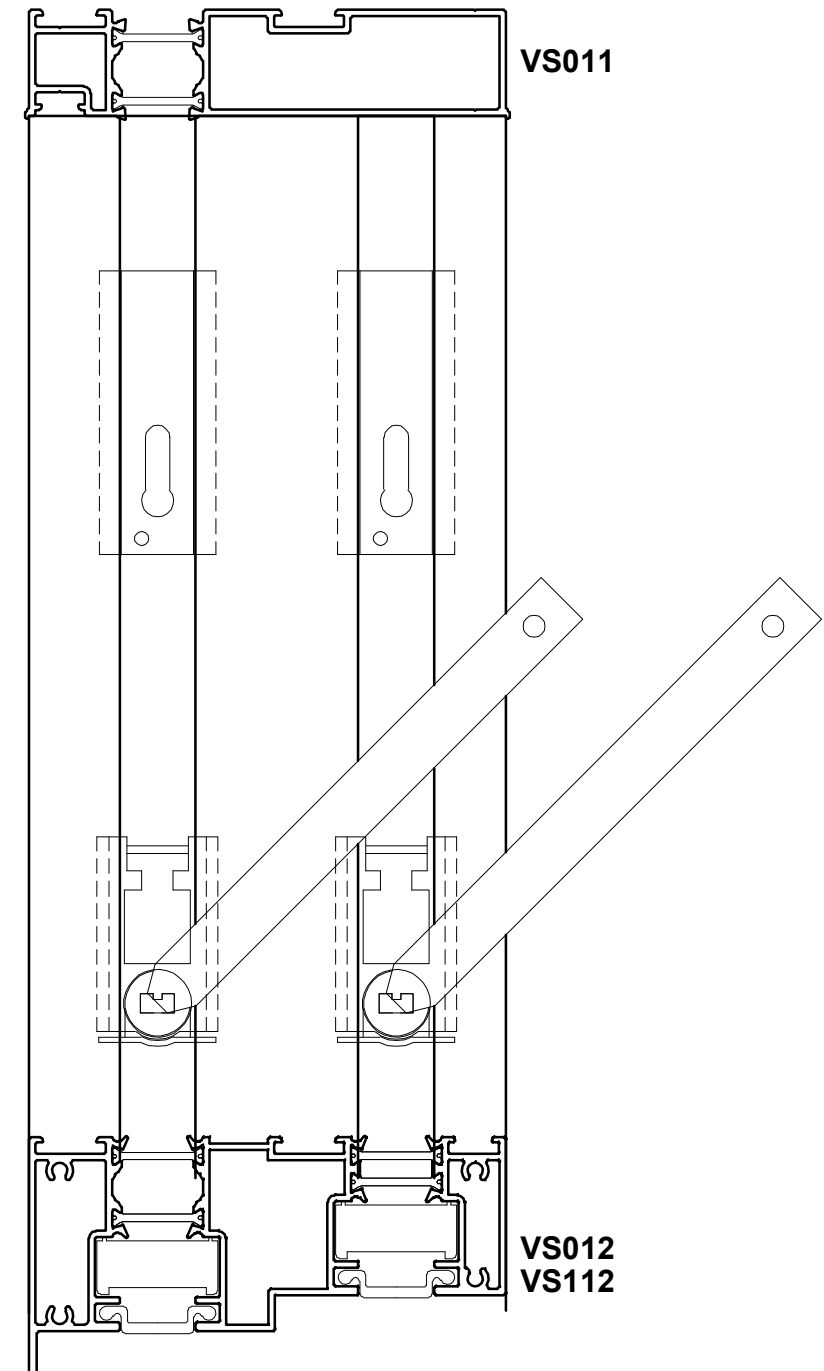
- 4 x Fixing Plates
- 2 x M5 x 35mm CSK S/S Screws
- 2 x M5 x 40mm CSK S/S Screws
- 4 x ACET067



Step Two:

Clip the pivot shoe and pivot bar together and insert into both channels of both jambs and lock into position by turning the pivot bar to a minimum of 45°.

With the woolpile in VS011, the outer frame can now be assembled.

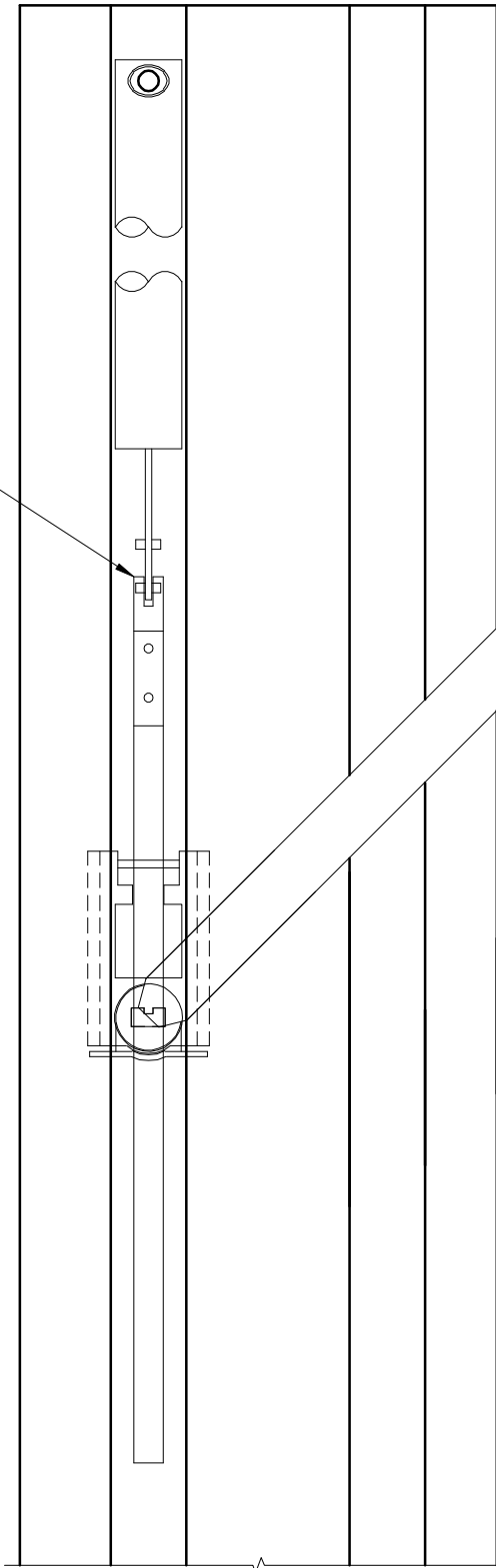
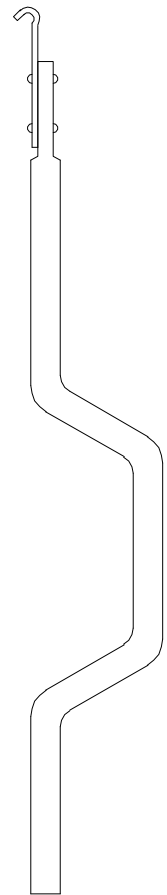


Do Not Scale From This Drawing

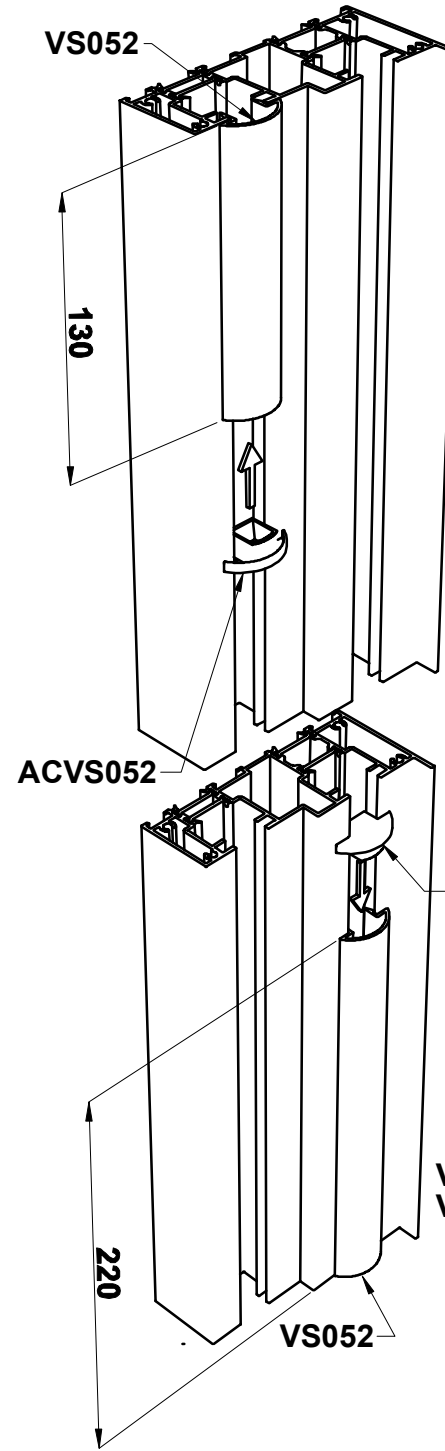
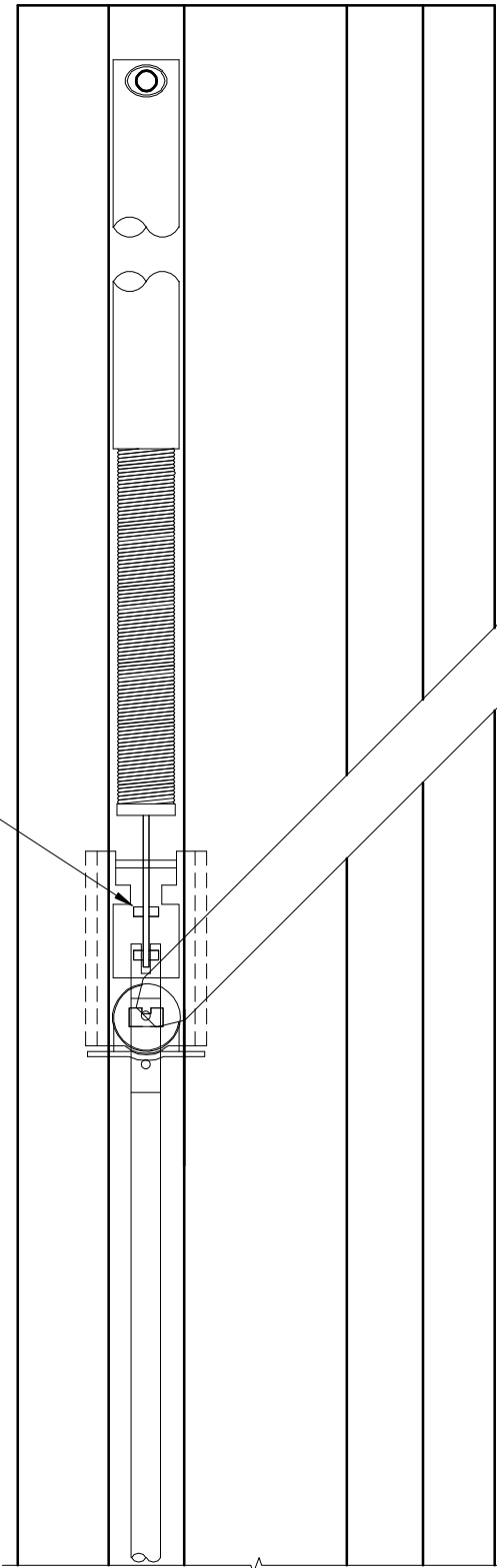
Attaching Spring Balances & Fitting Travel Stops

Step Three:
With the pivot shoes locked in position, use the hook tool to pull the spring over the pivot shoes to engage on the higher of the two pins

Hook over the bottom pins



Engage top pins over the pivot shoe



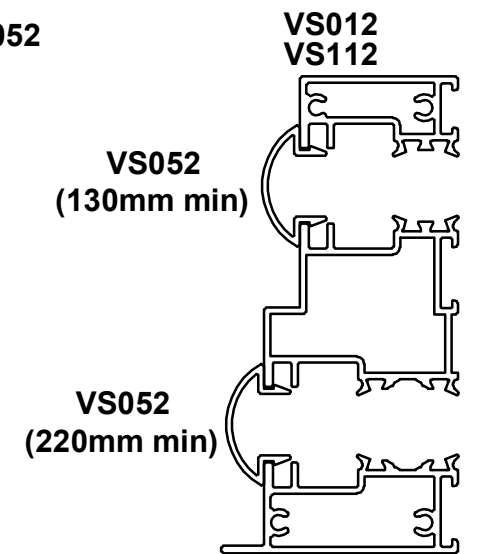
Guide to Travel Stops

Travel stops are essential whenever spring balances are in use. Travel stops ensure that the spring balances do not become damaged or prematurely worn.

If balances are over or under extended beyond their working range, irreparable damage may be caused to the internal spring. Travel stops prevent this.

The sizes shown are the minimum dimensions for an equal split design. For every 25mm that the upper sash is smaller than equally split, 50mm should be added to the upper sash travel length.

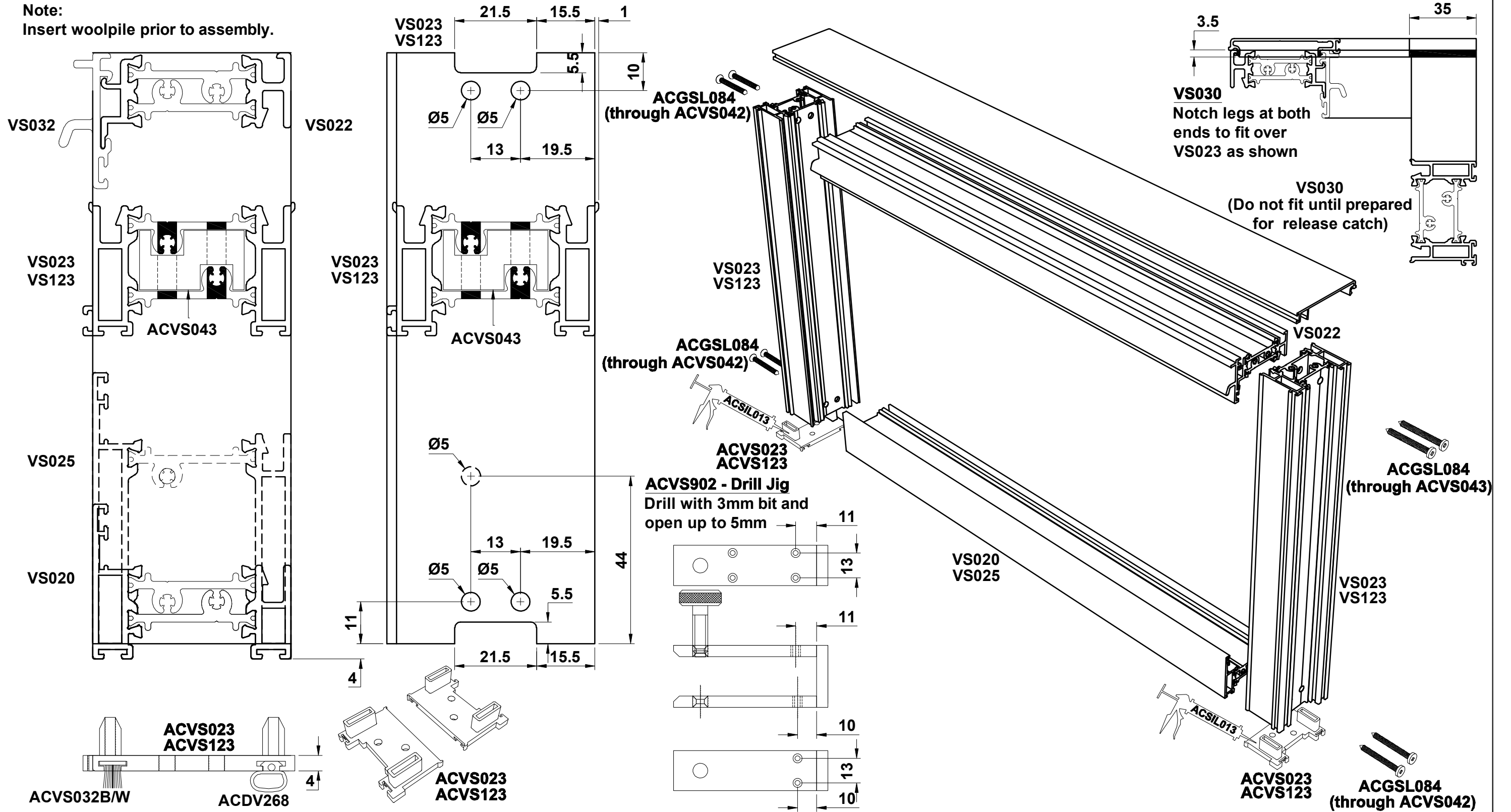
Do NOT operate the window until the upper & lower travel stops are fitted



Do Not Scale From This Drawing

Bottom Sash Assembly

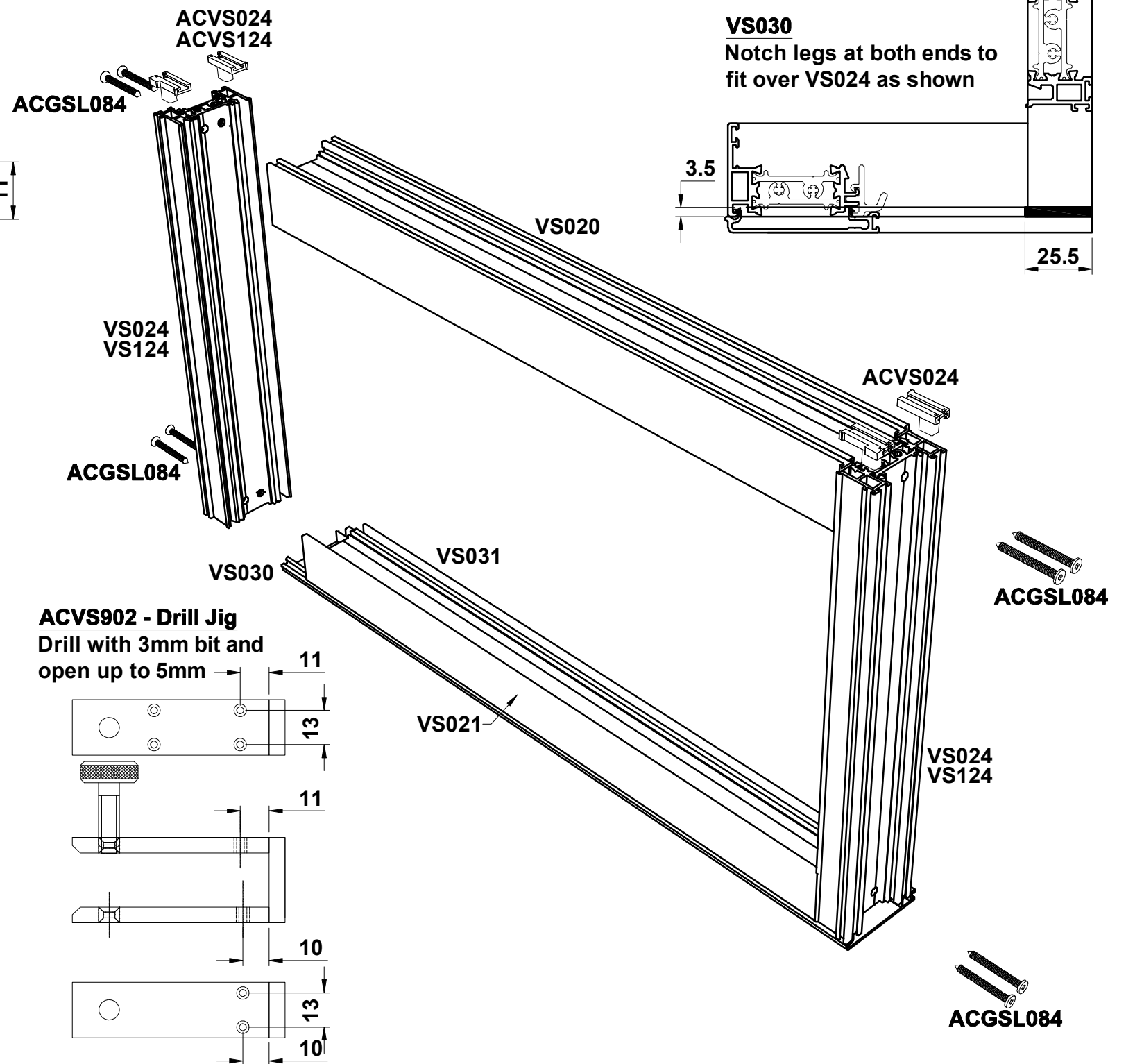
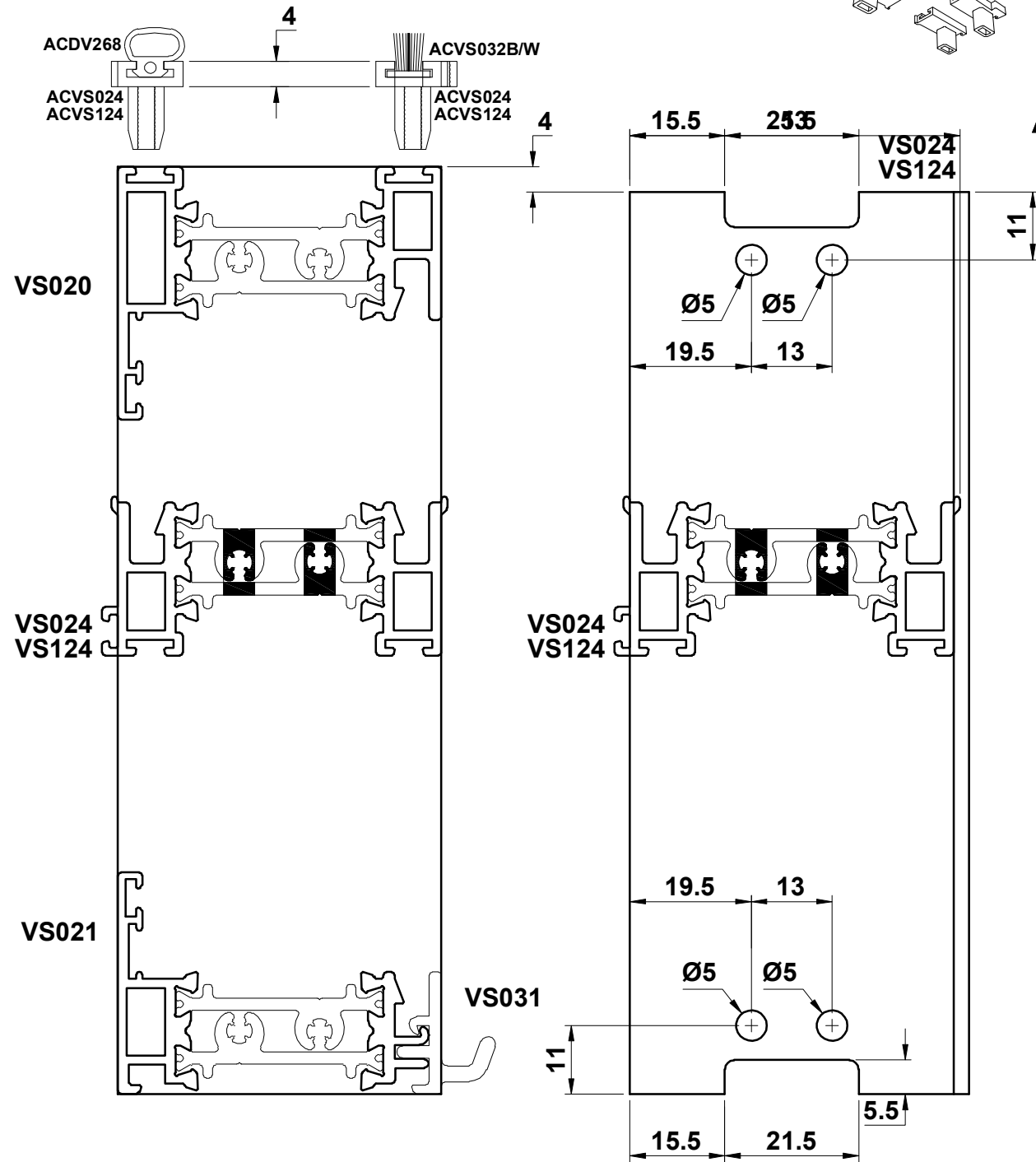
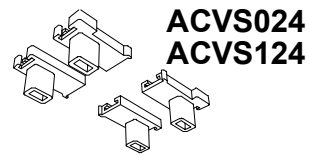
Note:
Insert woolpile prior to assembly.



Do Not Scale From This Drawing

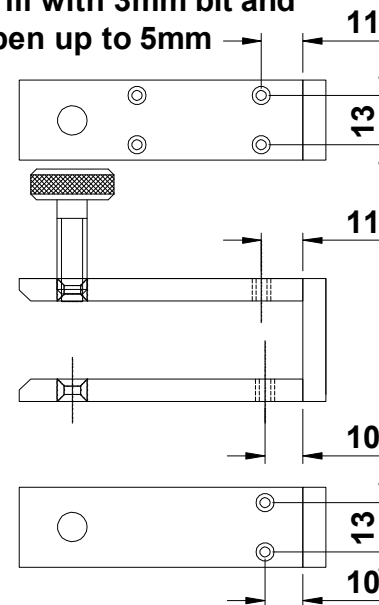
Top Sash Assembly

Note:
Insert woolpile prior to assembly.



ACVS902 - Drill Jig

Drill with 3mm bit and open up to 5mm

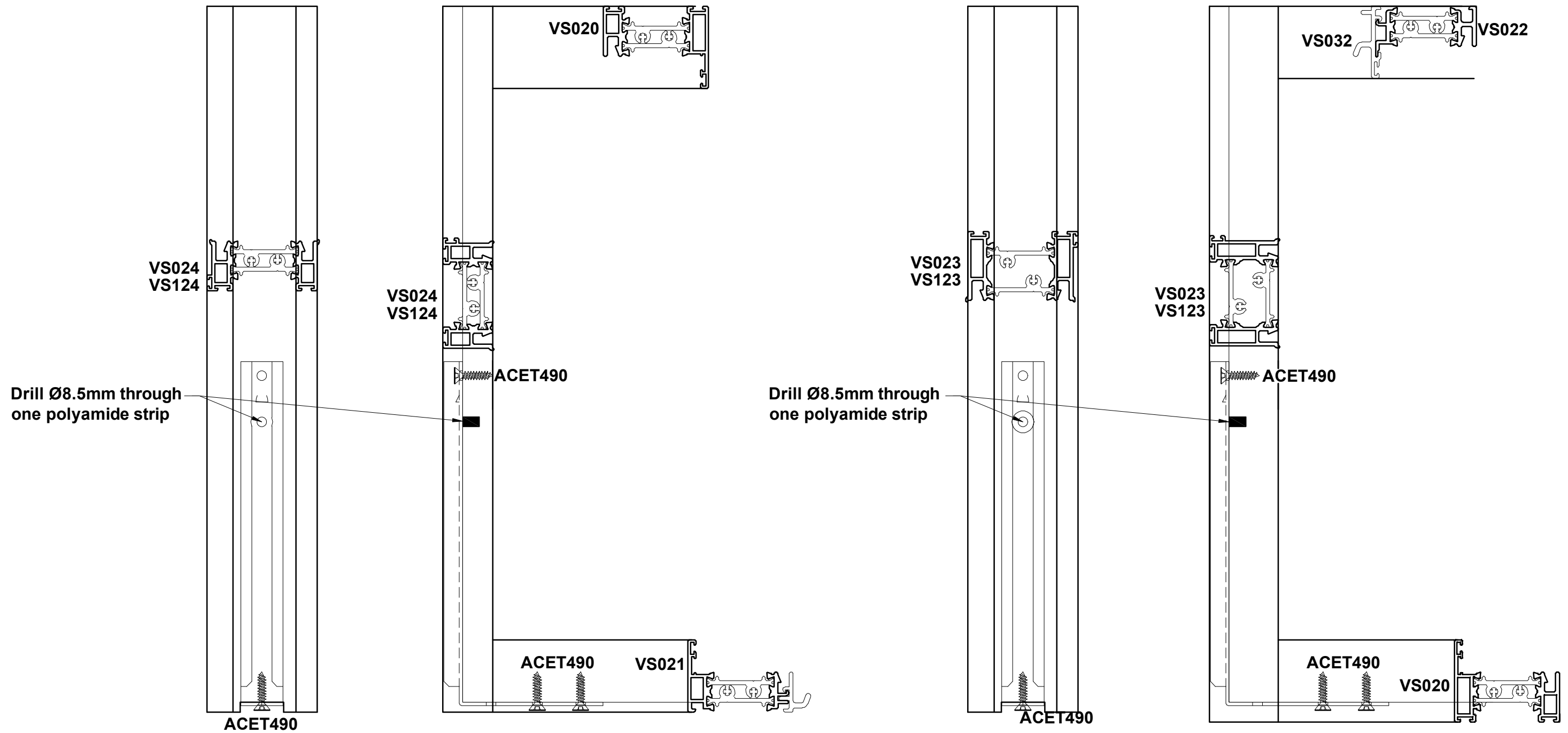


Do Not Scale From This Drawing

Pivot Bar Carrier Fitting

Top Sash

Bottom Sash



Do Not Scale From This Drawing

Release Catch Fitting & VS030 Preparation

Bottom Sash

Align catch so the square edge is flush with the legs as shown

Outside

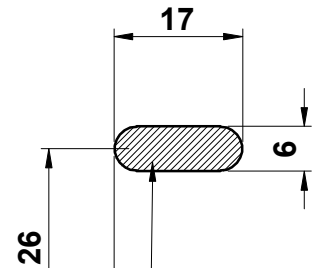
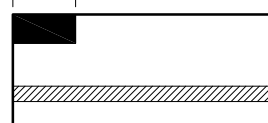
Fix through this hole first using ACET490

Tilt Latch Knob UK545

ACET490

Fix through this hole second using ACET490

8.5



34

50

This slot is used for the handle of the catch - UK545:



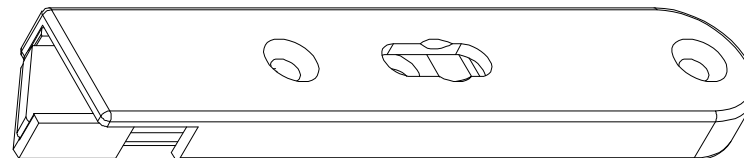
VS030N

3.5

6

3

Tilt Latch UK478
(Left Hand Shown)



Top Sash

Align catch so the square edge is flush with the legs as shown

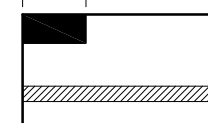
Outside

Use ACET490 to fix

Tilt Latch Knob UK858

ACET490

8.5



21.5

15

10

24.5

VS030N

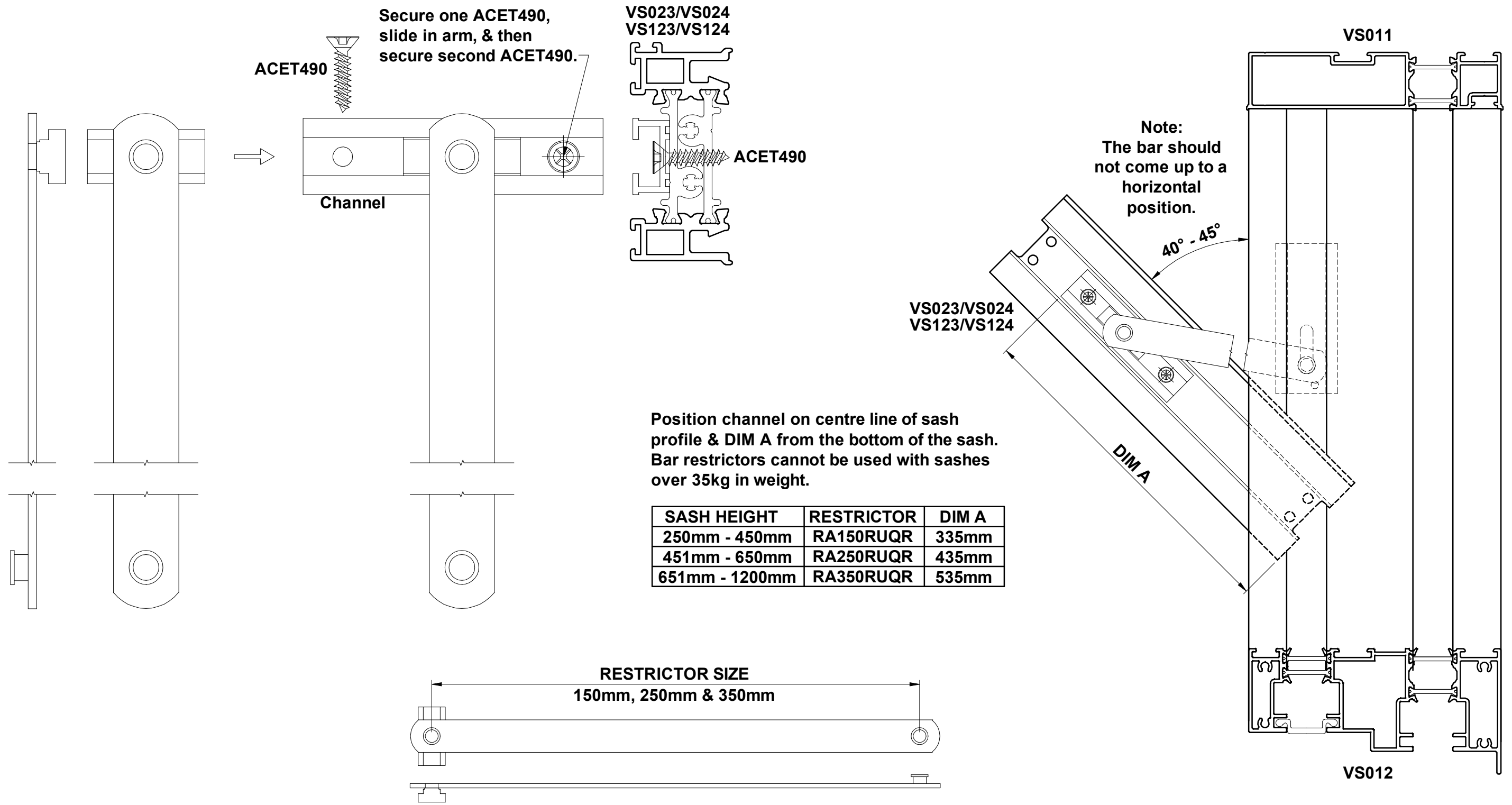
3.5

6

3

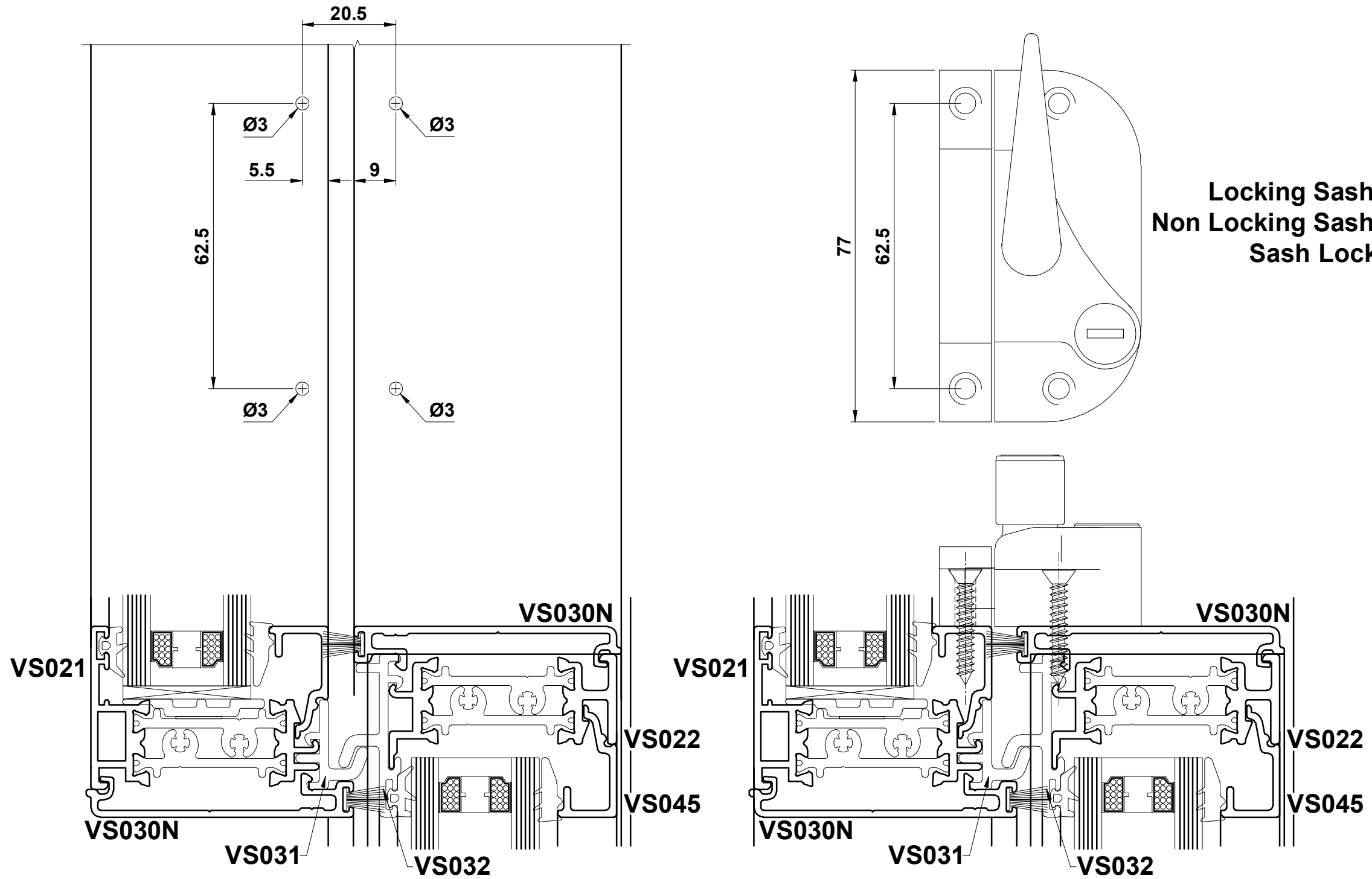
Do Not Scale From This Drawing

Bar Tilt Restrictor Fitting



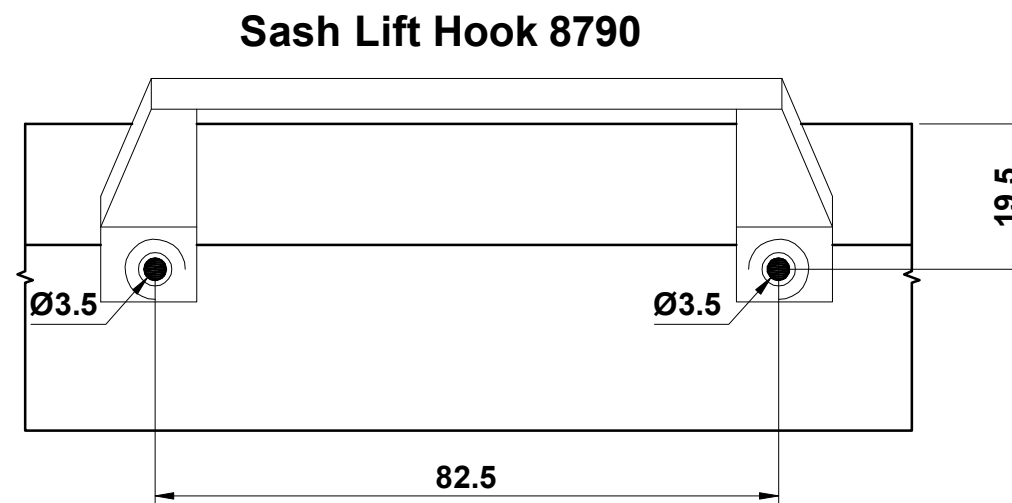
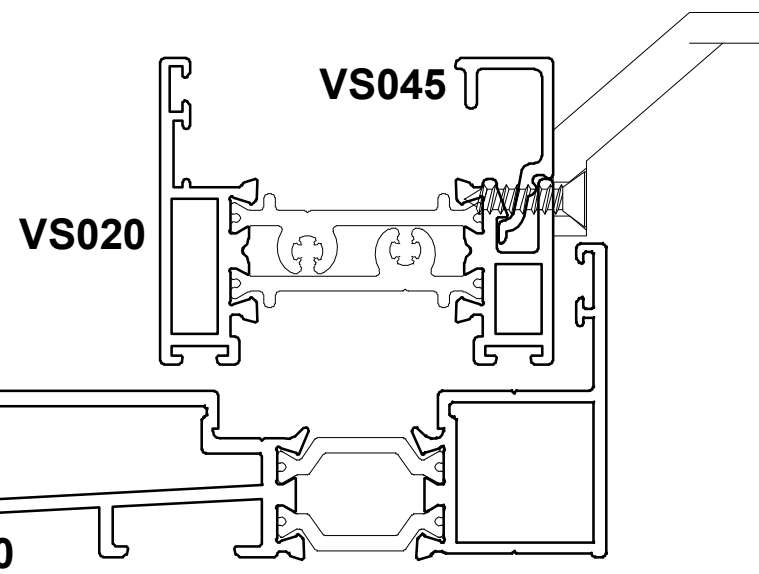
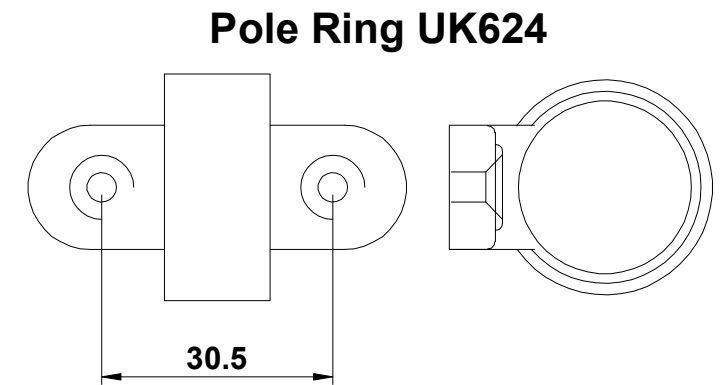
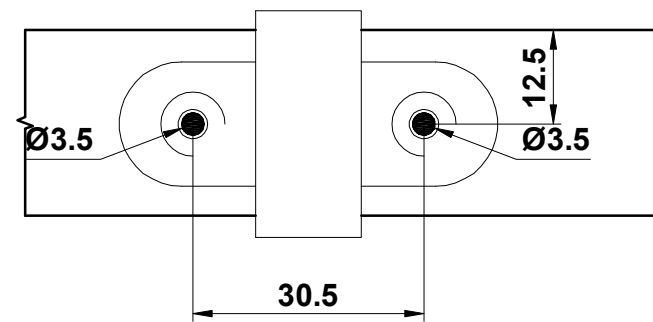
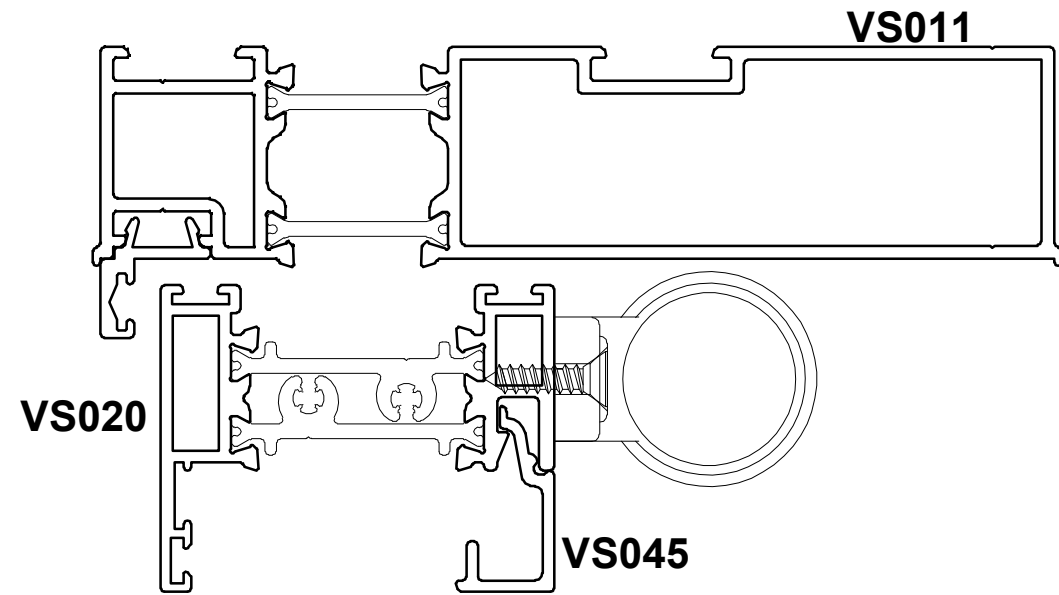
Do Not Scale From This Drawing

Sash Lock & Keep



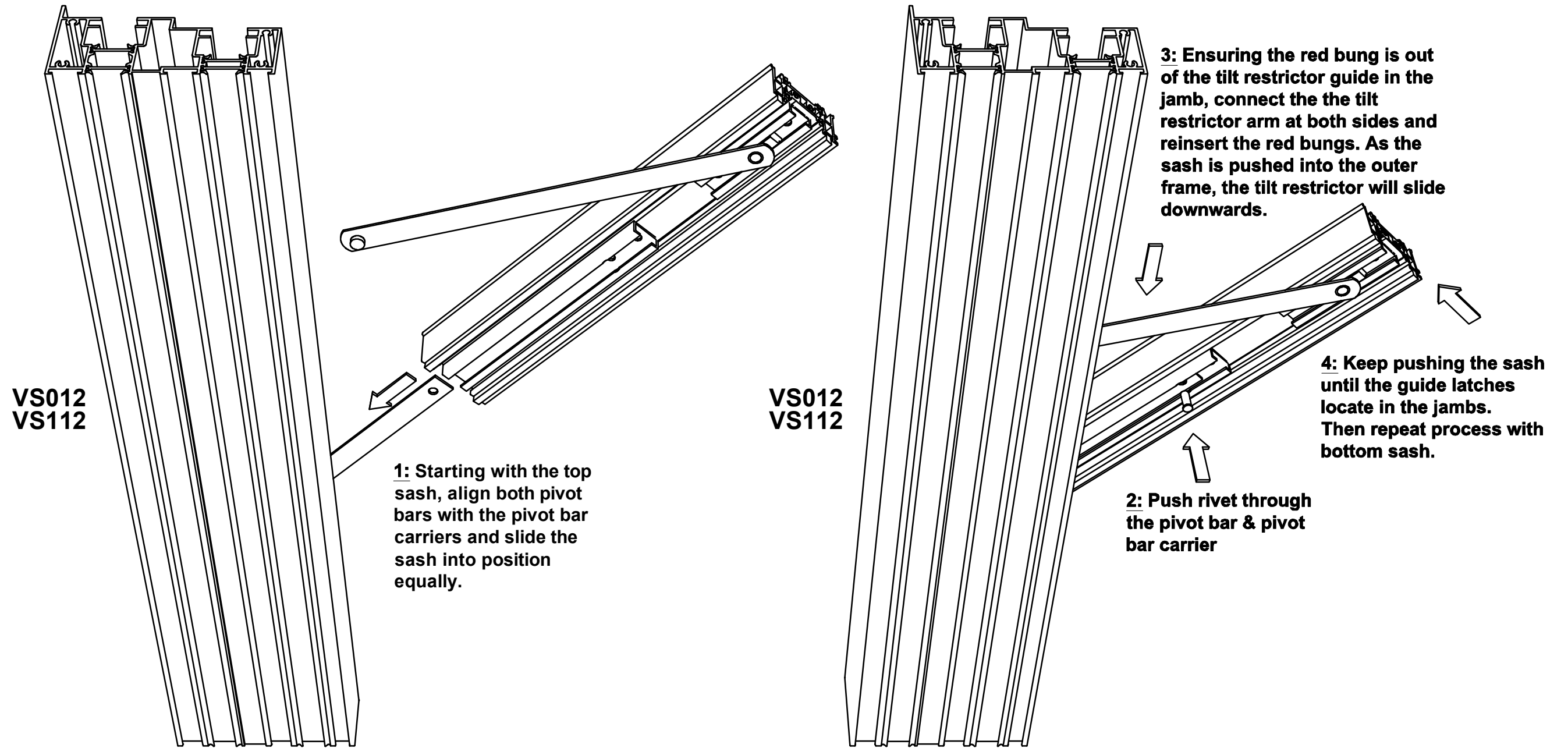
Do Not Scale From This Drawing

Fitting Details of Operating Hooks & Rings



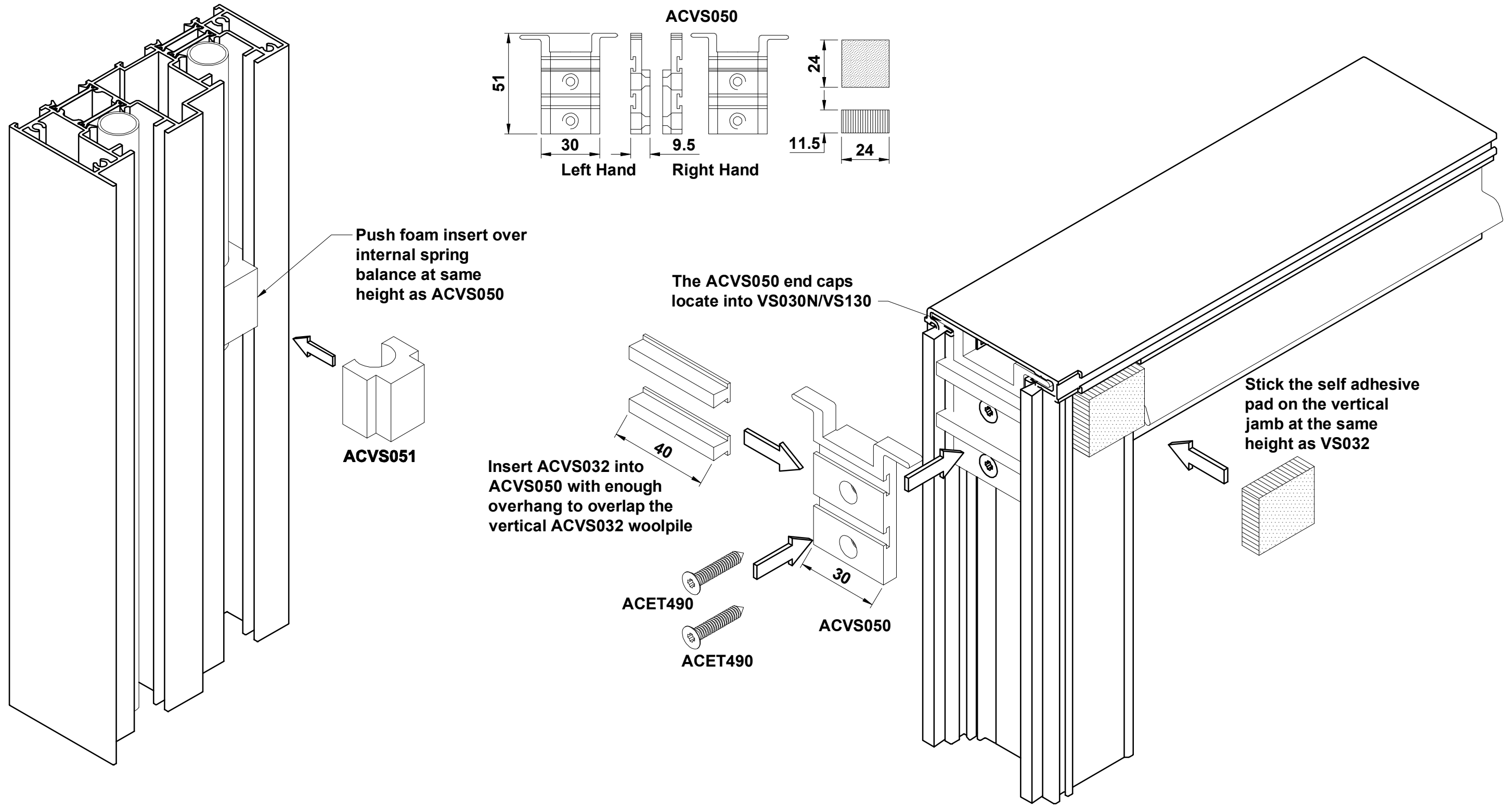
Do Not Scale From This Drawing

Inserting Sashes Into Outer Frame

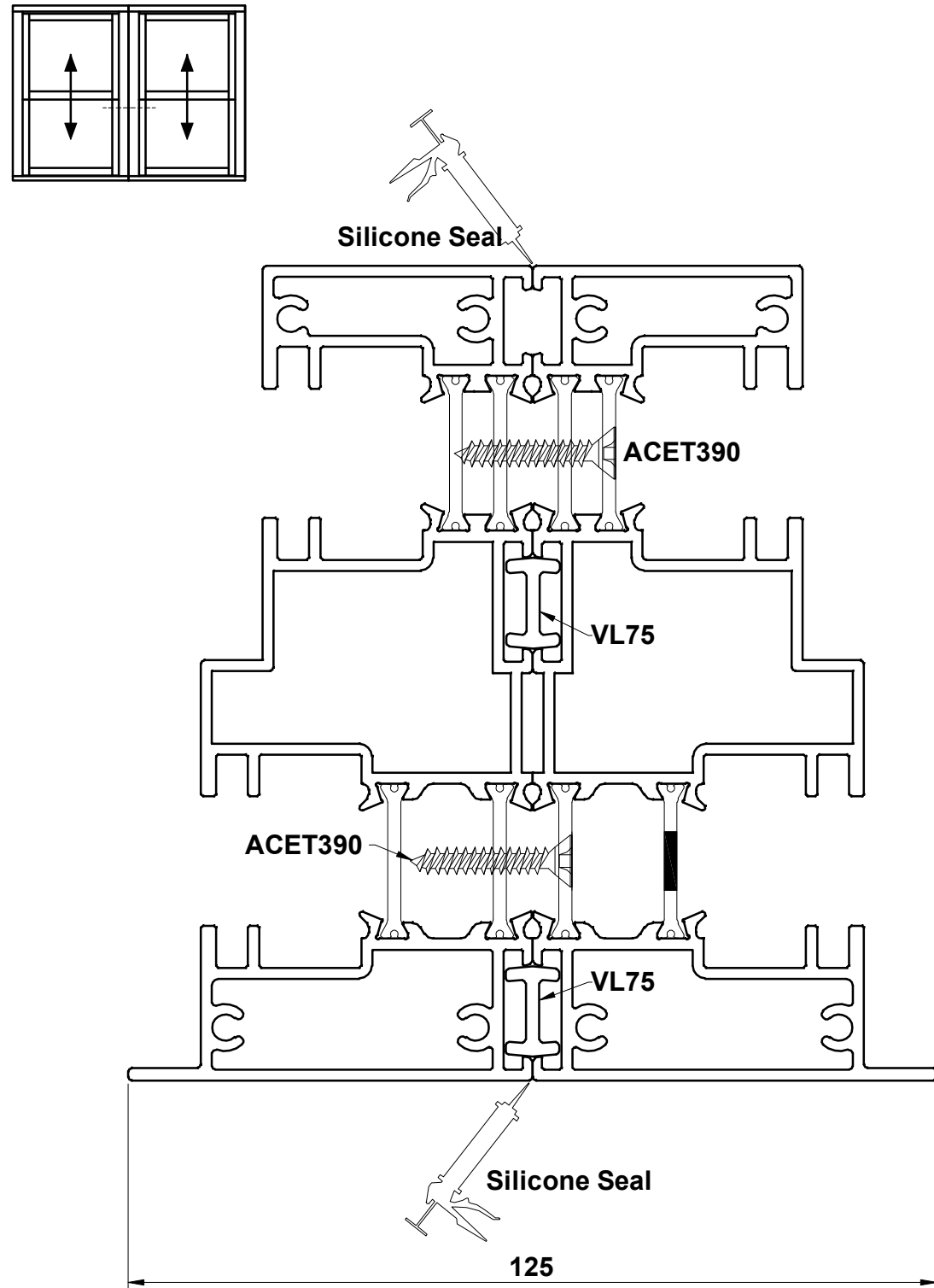


Do Not Scale From This Drawing

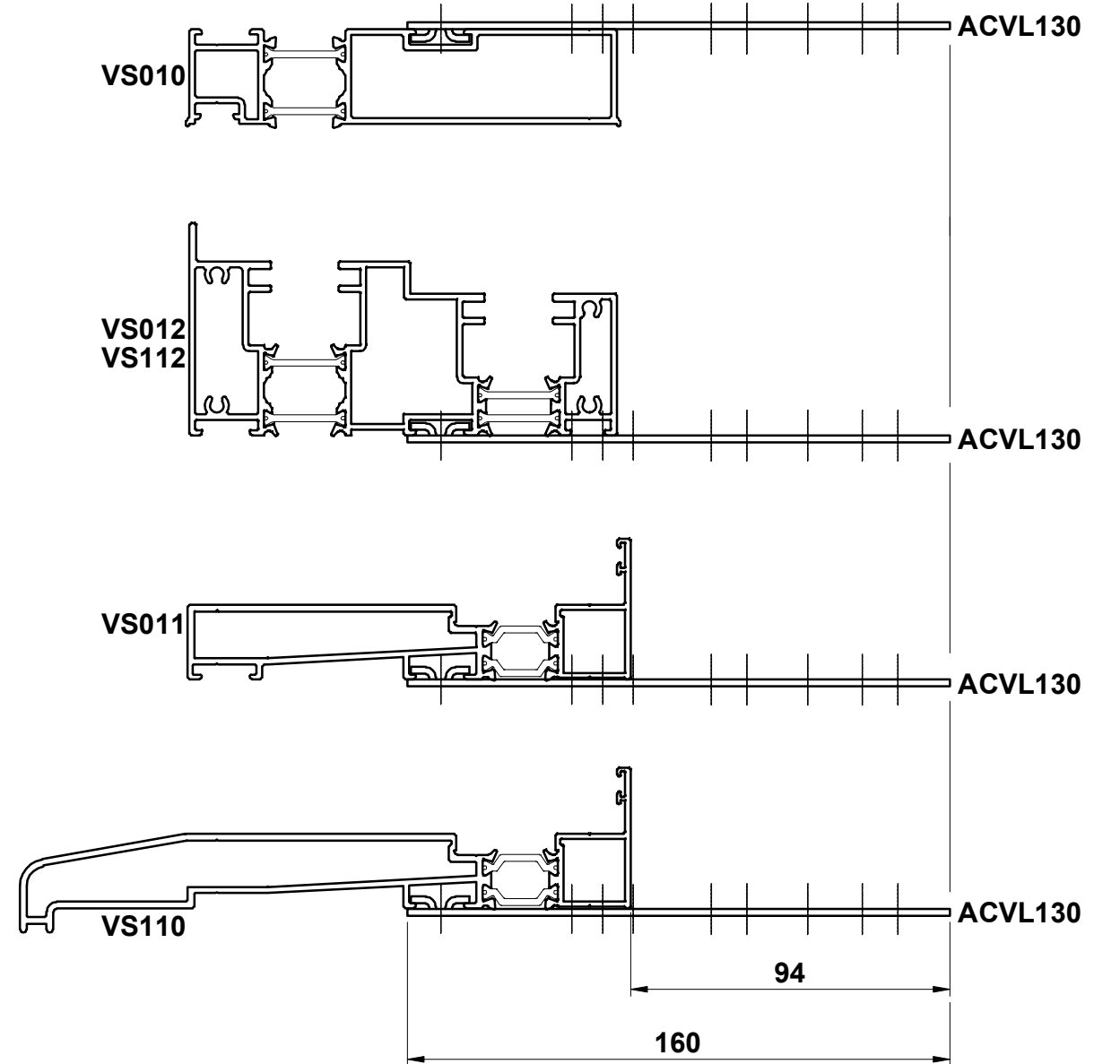
Bottom Sash Weather Enhancement Details



Coupling & ACVL130



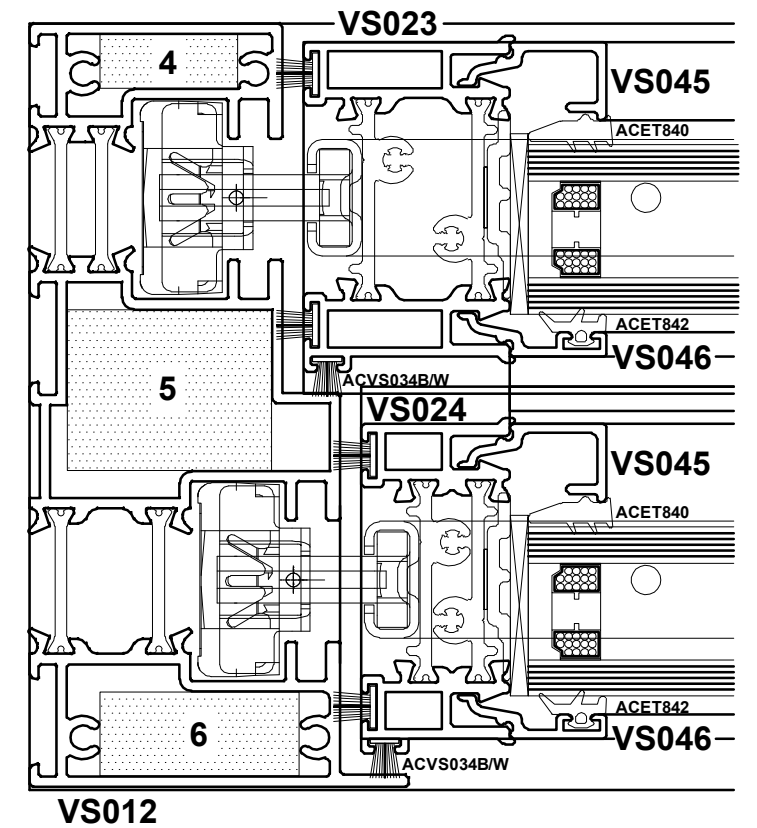
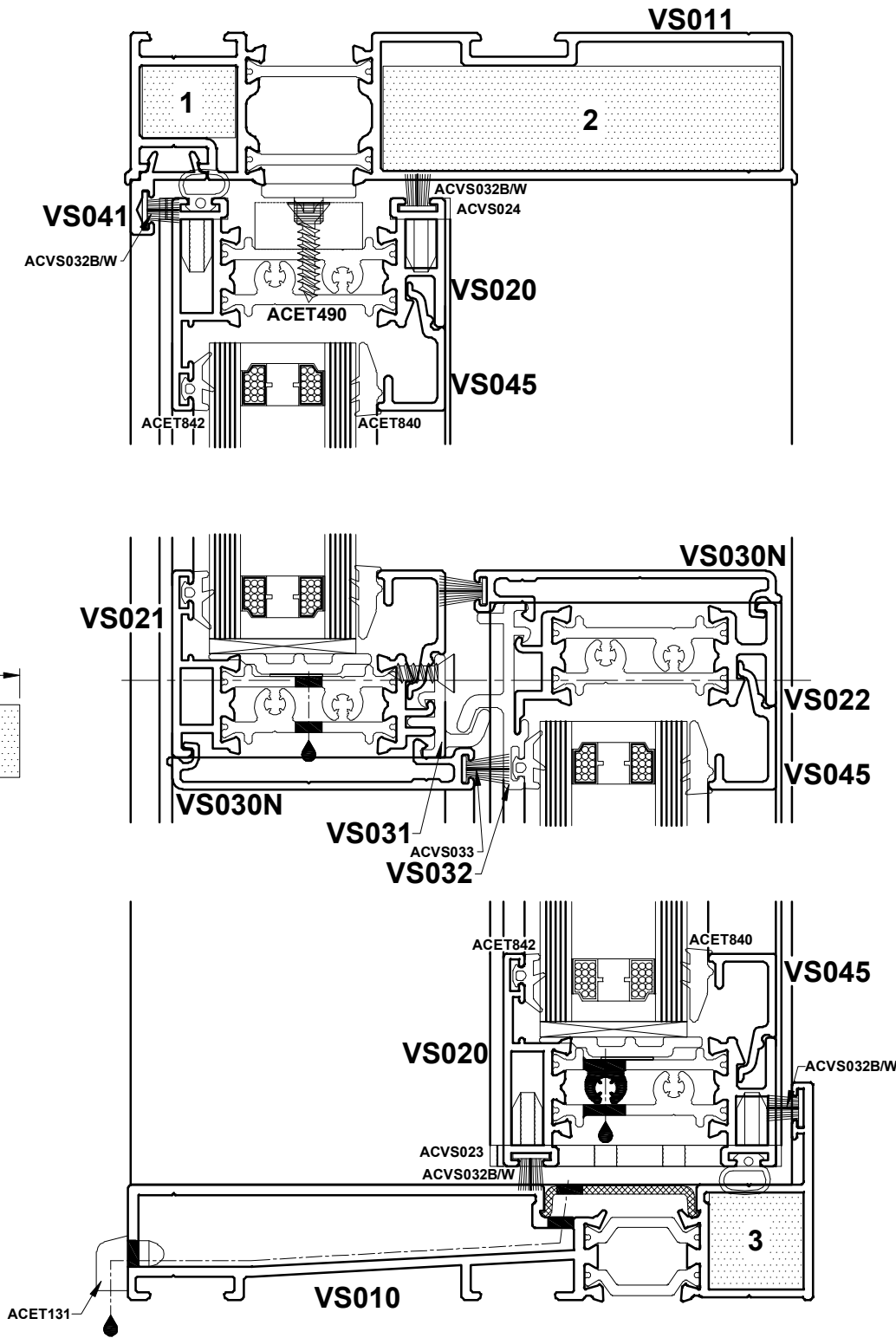
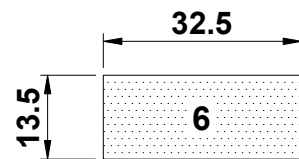
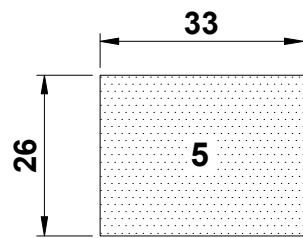
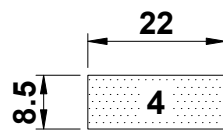
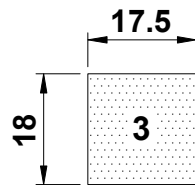
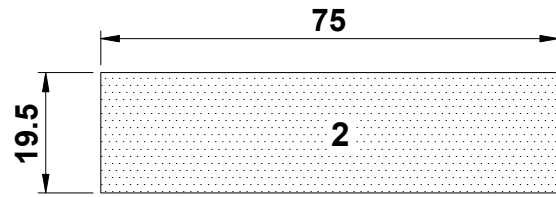
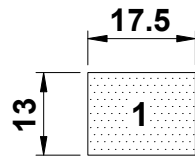
ACVL130



Do Not Scale From This Drawing

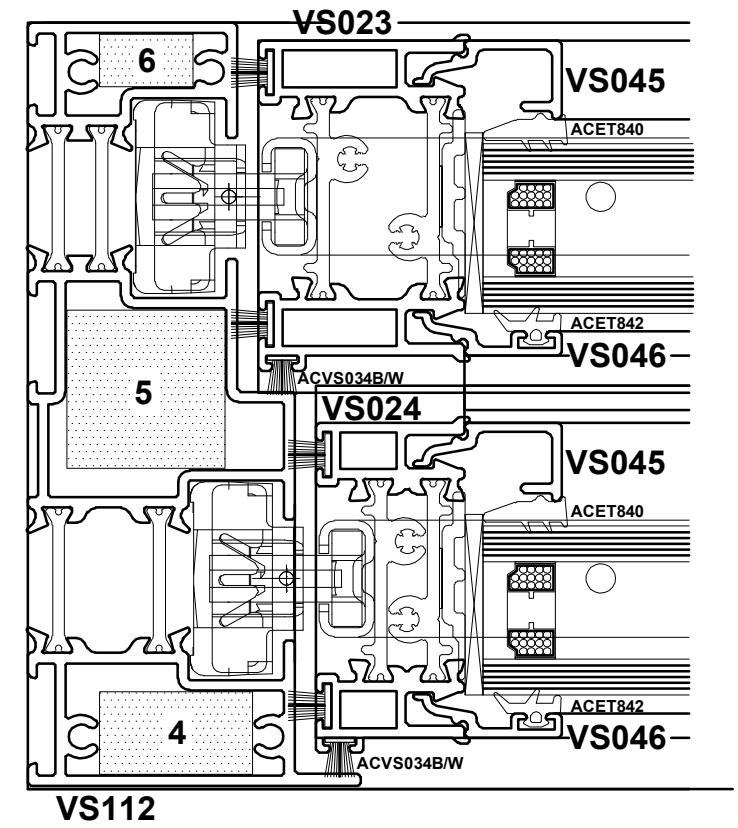
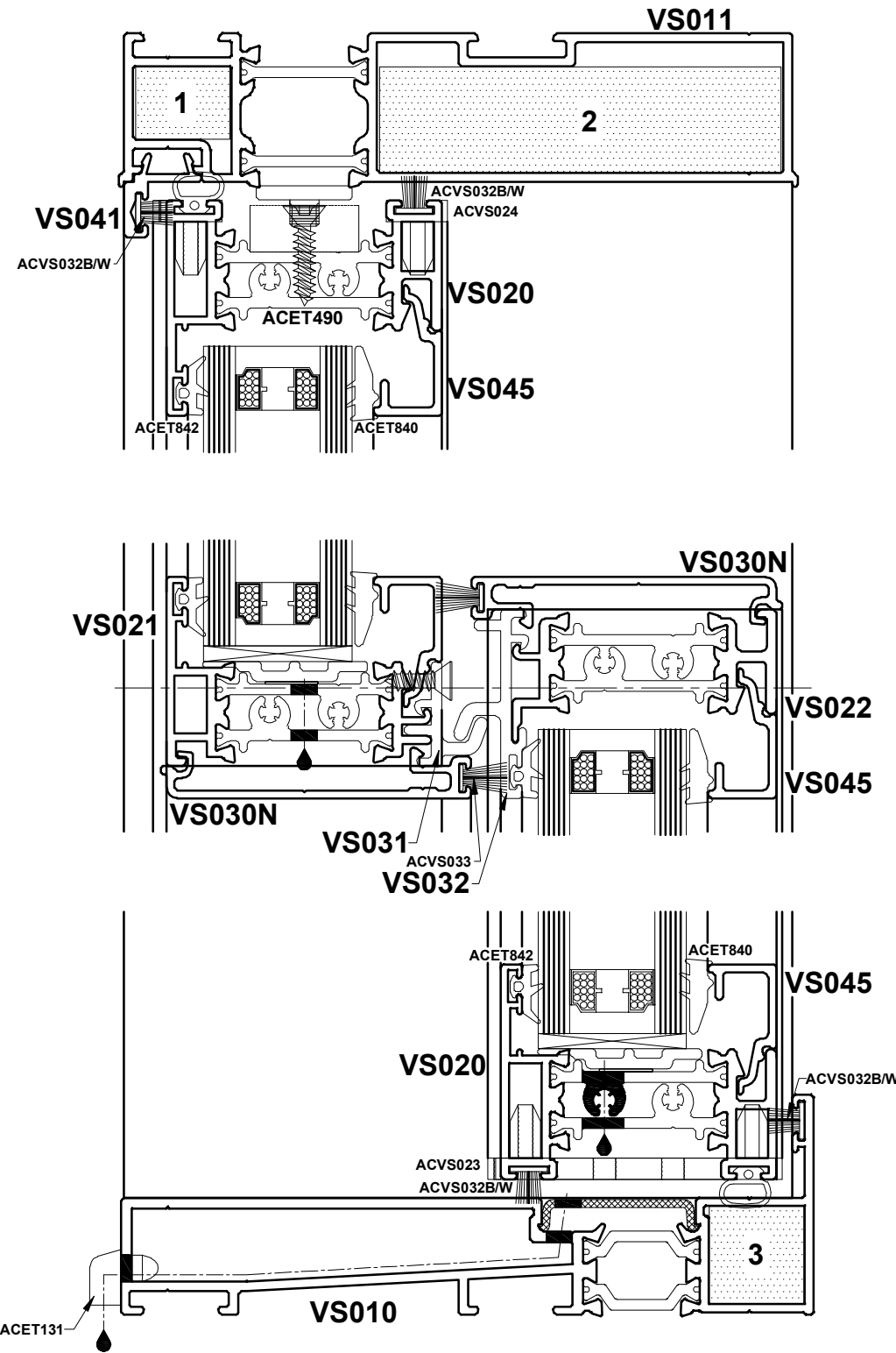
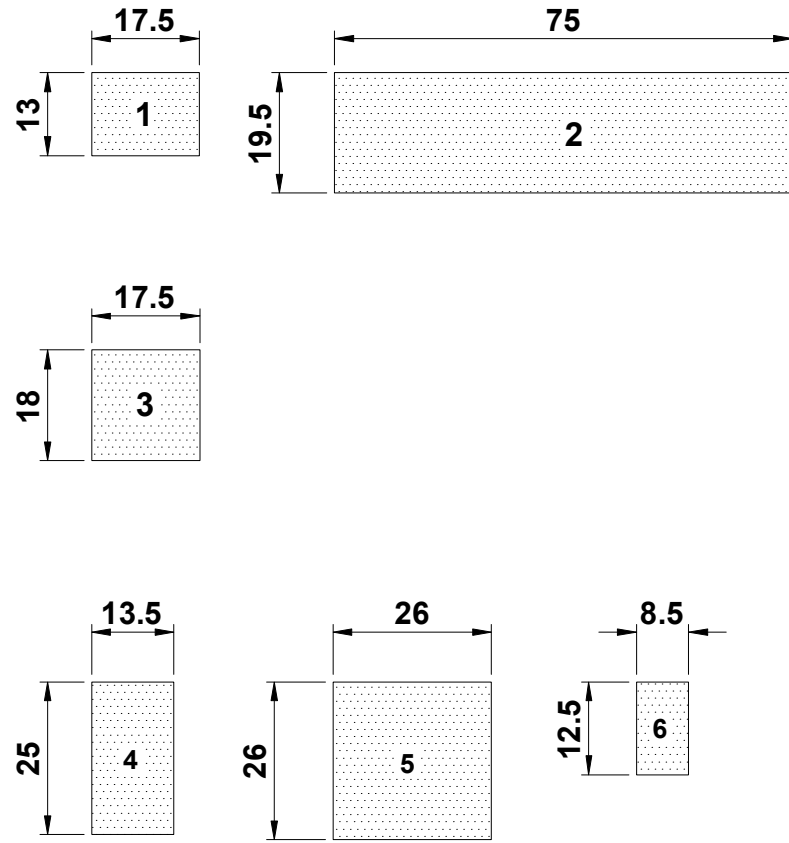
ACVS100 Foam Insulation

ACVS100 (1250mm lengths)

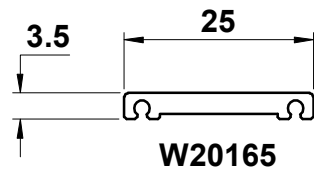
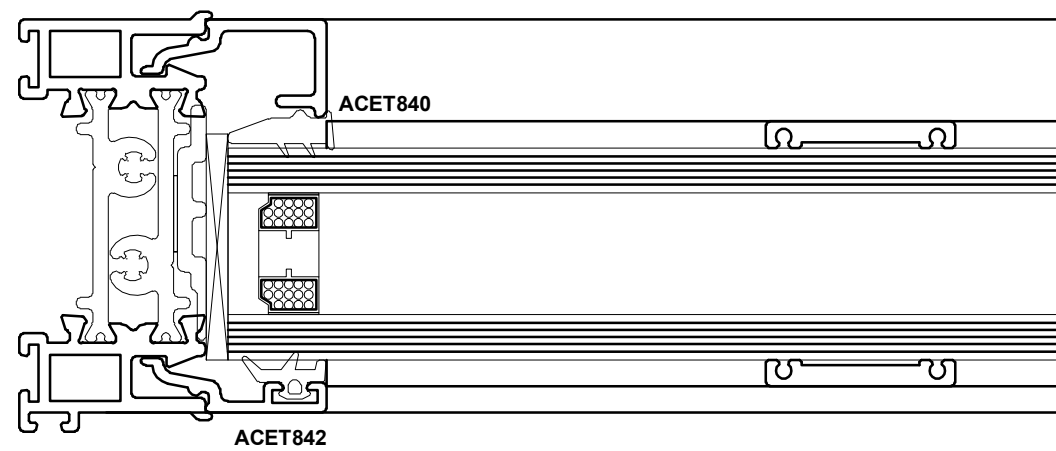


ACVS101 Foam Insulation

ACVS101 (1250mm lengths)

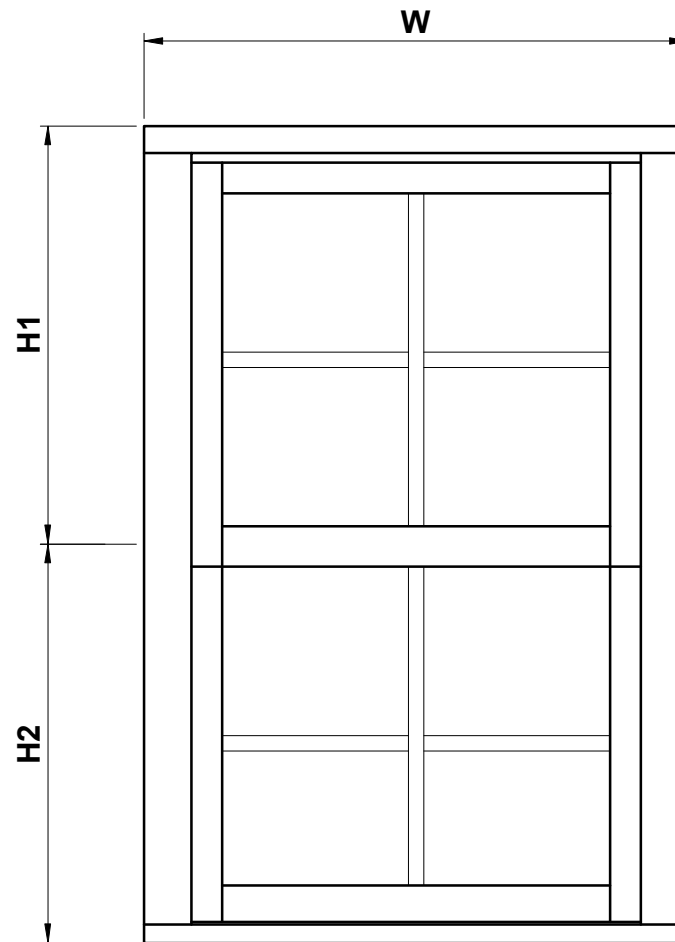


Do Not Scale From This Drawing



Recommended Tape = GPAL1103 15150 BP (15x1mm) Black
Supplier = UK Industrial Tapes Tel: 0191 2697810

Note: Clean glass with a non-residue glass cleaner prior to applying the taped bar to the unit.
A small silicone bead may be applied to the bars after bonding to the unit to extend the life of the tape.



TOP SASH

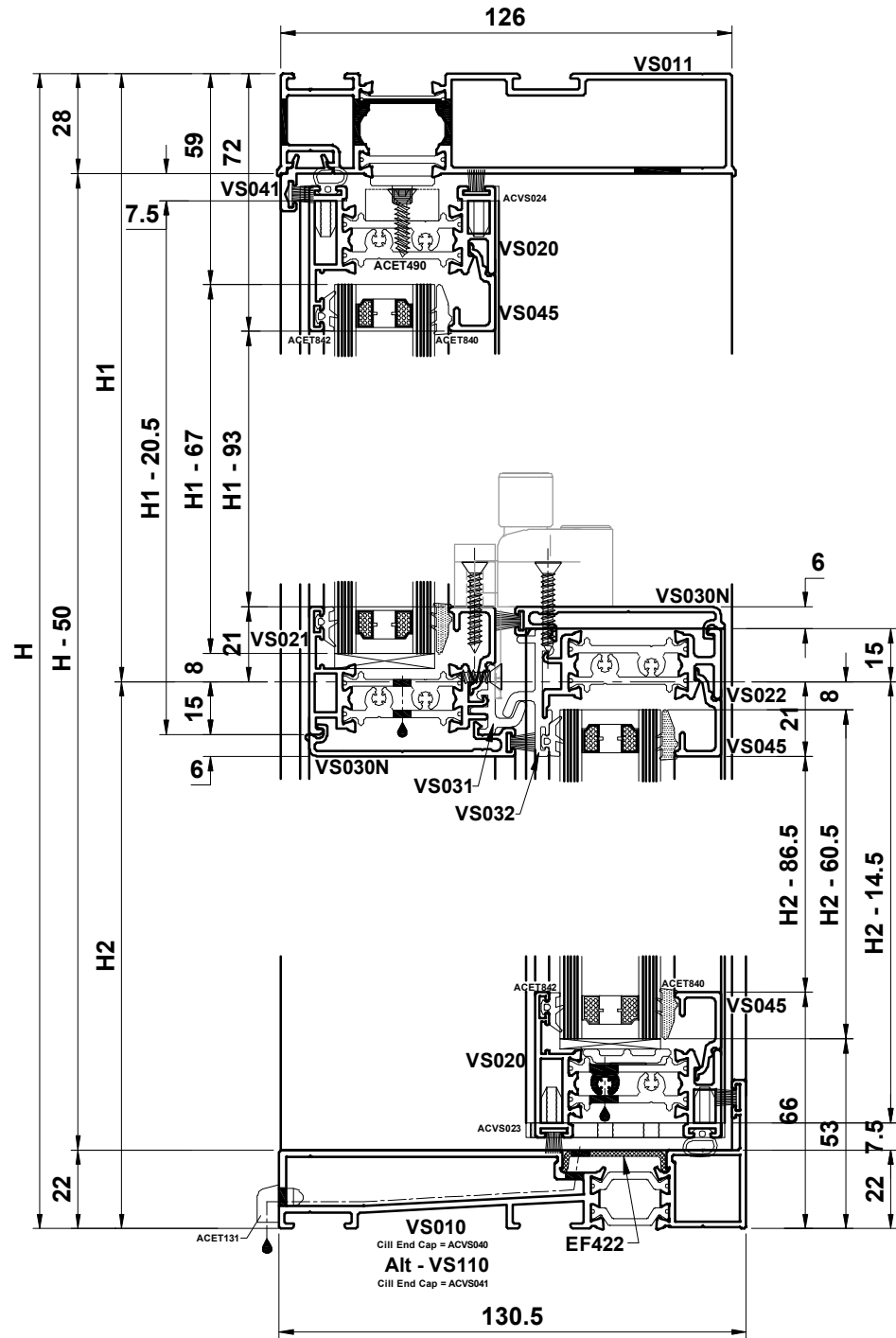
Horizontal bars (1 x vertical bars) = $(W-108)/2$
Horizontal bars (2 x vertical bars) = $(W-241)/3$
Horizontal bars (3 x vertical bars) = $(W-266)/4$
Vertical bar = $H1-93$

BOTTOM SASH

Horizontal bars (1 x vertical bars) = $(W-108)/2$
Horizontal bars (2 x vertical bars) = $(W-241)/3$
Horizontal bars (3 x vertical bars) = $(W-266)/4$
Vertical bar (VS020 btm rail) = $H2-86.5$
Vertical bar (VS025 btm rail) = $H2-121.5$

Section F

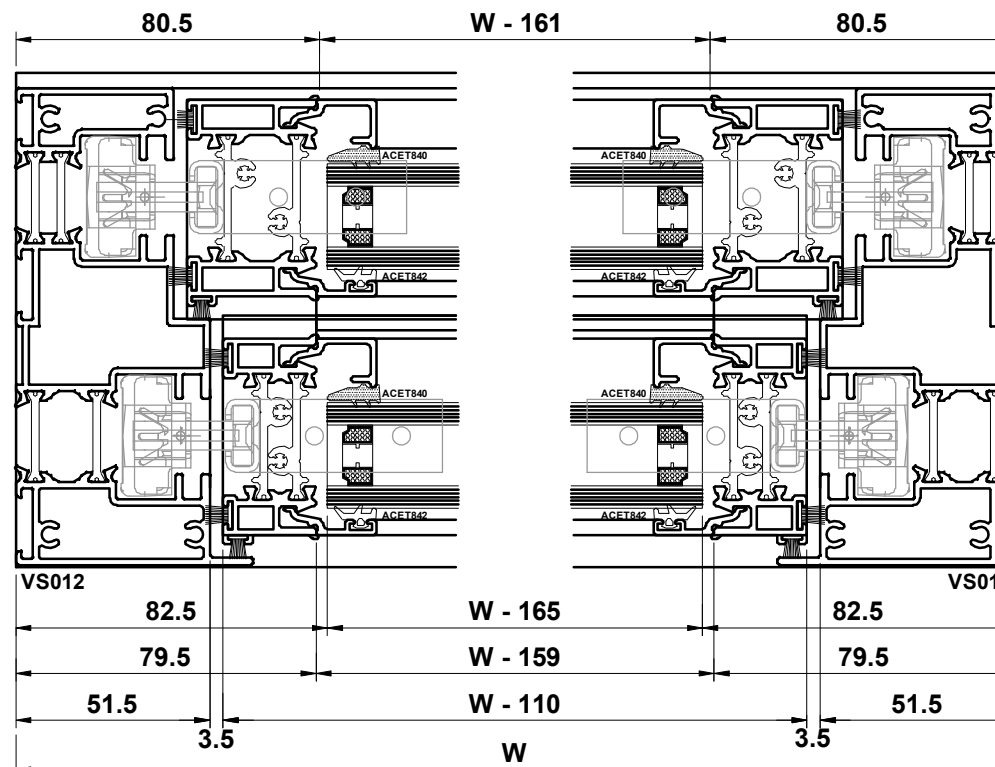
Cutting Information - Standard Bottom Rail



PROFILE CUTTING SCHEDULE

Profile	Quantity	Material	Dimensions
VS010/VS110	1	W	W
VS011	1	W	W
VS012	2	H - 50	H - 50
VS041	1	W - 125	W - 125
EF422	1	W	W
VS020	2	W - 159	W - 159
VS021	1	W - 159	W - 159
VS022	1	W - 159	W - 159
VS023/VS123	2	H2 - 14.5	H2 - 14.5
VS024/VS124	2	H1 - 20.5	H1 - 20.5
VS030/VS130	1	W - 110	W - 110
VS030/VS130	1	W - 91	W - 91
VS031	1	W - 161	W - 161
VS032	1	W - 161	W - 161
VS044/VS045	4	W - 161	W - 161
VS044/VS045	2	H2 - 86.5	H2 - 86.5
VS044/VS045	2	H1 - 93	H1 - 93
VS046	2	H2 - 86.5	H2 - 86.5
VS046	2	H1 - 93	H1 - 93
VS052	2	220	220
VS052	2	130	130

GLASS SIZES	Quantity	Dimensions
	1 x	H1 = W - 165 x H1 - 67
	1 x	H2 = W - 165 x H2 - 60.5



ACCESSORIES

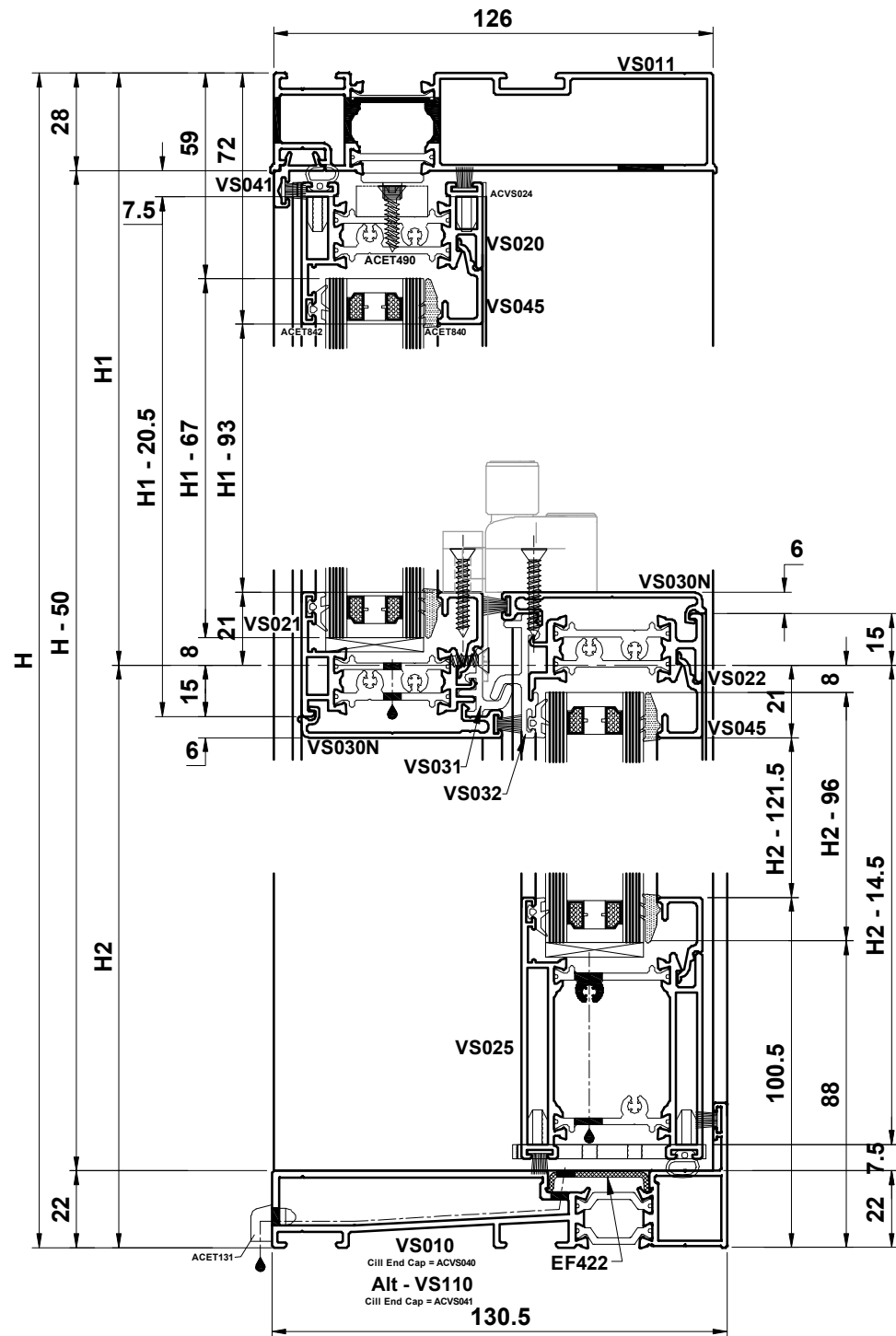
Accessory	Quantity	Description
ACDV268	2 x (W-84)	Bubble Gasket
ACET067	6	Lock & Keep Screws
ACET131	2	Drainage Cover Cap
ACET490	28	Polyamide Screws
ACGSL084	16	Sash Assembly Screws
ACET840	4 x (W-160) + 4 x (H-120)	Wedge Glazing Gasket
ACET842	4 x (W-160) + 4 x (H-120)	External Glazing Gasket
ACVS032B/W	4 x (W-84) + 8 x (H/2)	Woolpile (Approx Sizes)
ACVS033	2 x W-84	Woolpile (Approx Sizes)
ACVS034B/W	4 x (H/2)	Woolpile (Approx Sizes)
ACVS023	1 Pair	VS023 End Caps
ACVS024	1 Pair	VS024 End Caps
ACVS040/ACVS041	1 Pair	VS010/VS110 End Caps
ACVS042	1	Balance Fixing Kit
ACVS043	4	VS023 Polyamide Support
ACVS052	4	VS052 Travel Stop End Caps
ACVS057	16	Bridge Packer
PUA028	12	Outer Frame Screws
ACDR052	4	Outer Frame Screws

CALDWELL ACCESSORIES

Accessory	Quantity	Description
KL800 / NL800	1 (2 if over 800 wide)	Locking Sash Lock/Non locking Sash lock
30459	1 (2 if over 800 wide)	Keep
Ultralift	1 pair	Top Balances
Ultralift	1 pair	Bottom Balances
PE739	4	Pivot Shoes
UK526	4	Pivot Bar Carrier
UK507	4	Pivot Bar
UK469	4	Push-in Rivet
UK472L/R	4	Tilt Latch
UK858	2	Top Guide Latch Operating Button
UK545	2	Bottom Guide Latch Operating Button
RA*50RUQR	4	Tilt Restictor
UK624	1 (2 if over 800 wide)	Sash Ring
8790	1 (2 if over 800 wide)	Sash Lift Hook

Do Not Scale From This Drawing

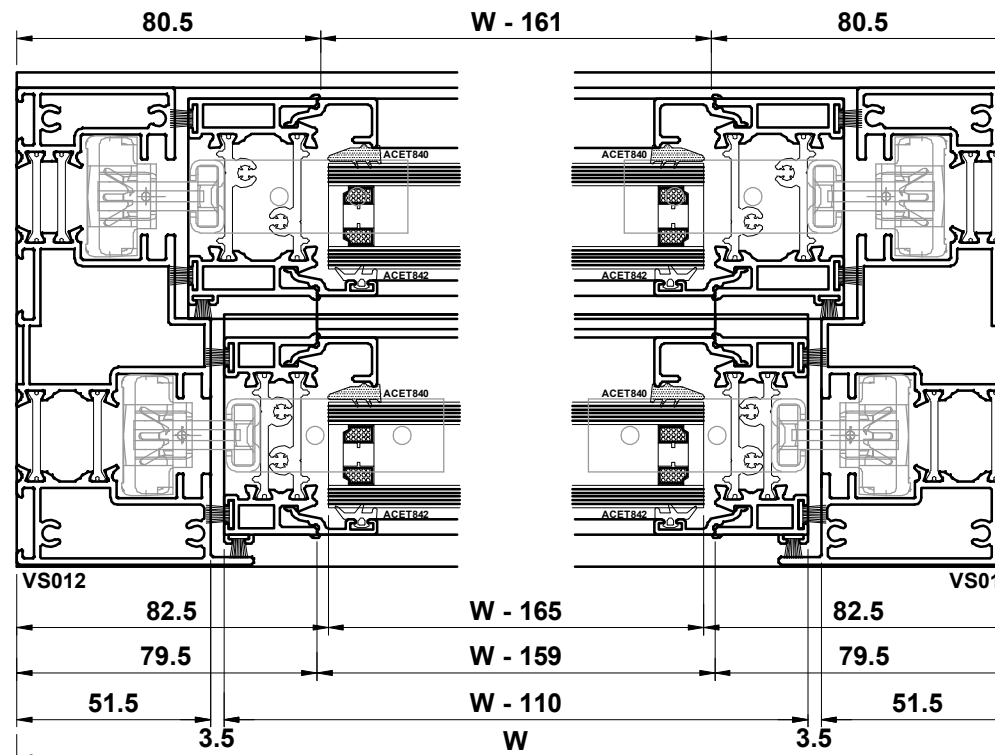
Cutting Information - Deep Bottom Rail



PROFILE CUTTING SCHEDULE

Profile	Quantity	Dimensions
VS010/VS110	1	W
VS011	1	W
VS012	2	H - 50
VS041	1	W - 125
EF422	1	W
VS020	1	W - 159
VS021	1	W - 159
VS022	1	W - 159
VS023/VS123	2	H2 - 14.5
VS024/VS124	2	H1 - 20.5
VS025	1	W - 159
VS030/VS130	1	W - 91
VS030/VS130	1	W - 110
VS031	1	W - 161
VS032	1	W - 161
VS044/VS045	4	W - 161
VS044/VS045	2	H2 - 121.5
VS044/VS045	2	H1 - 93
VS046	2	H2 - 121.5
VS046	2	H1 - 93
VS052	2	220
VS052	2	130

GLASS SIZES	Quantity	Dimensions
	1 x	H1 = W - 165 x H1 - 67
	1 x	H2 = W - 165 x H2 - 96



ACCESSORIES

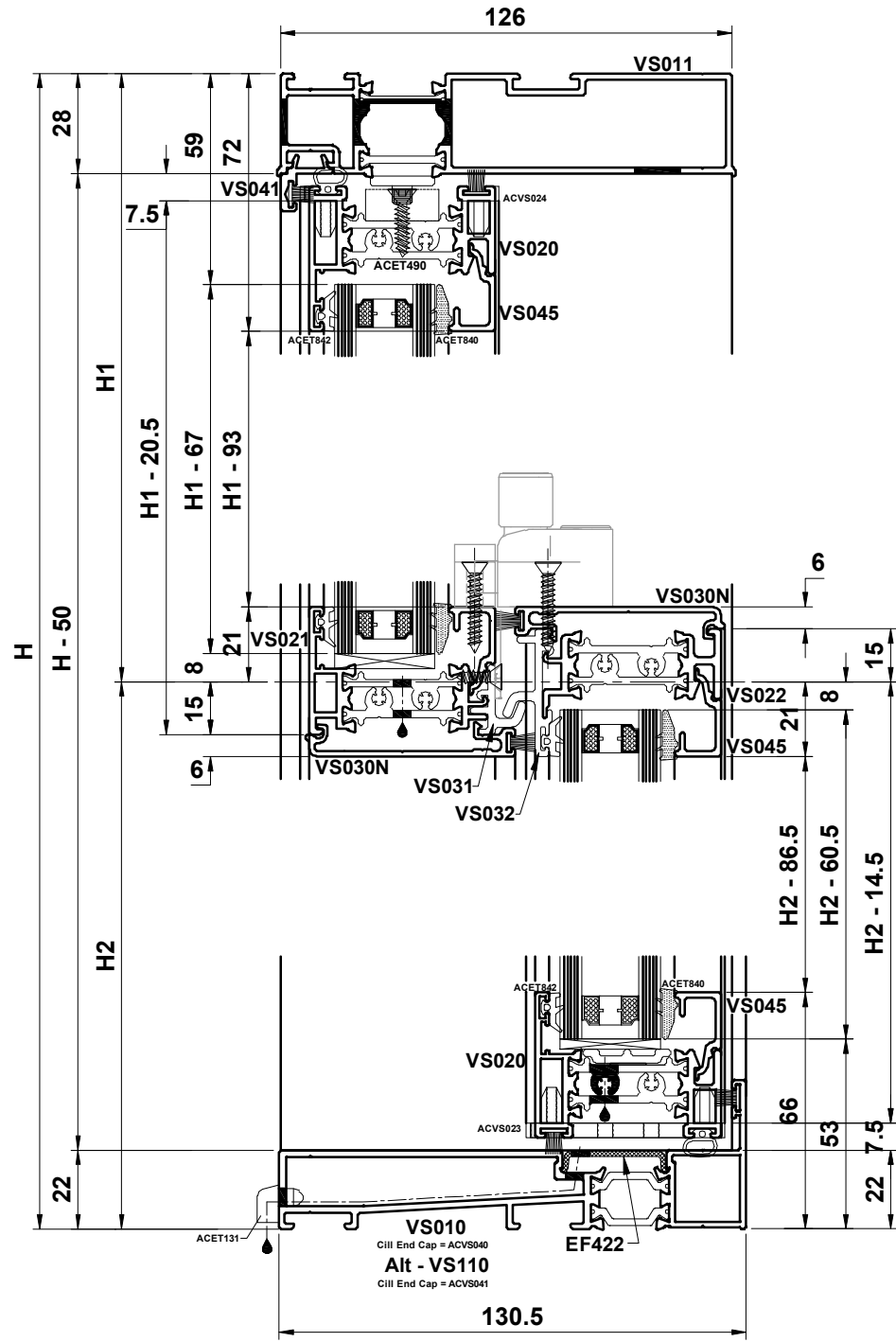
Accessory	Quantity	Description
ACDV268	2 x (W-84)	Bubble Gasket
ACET067	6	Lock & Keep Screws
ACET131	2	Drainage Cover Cap
ACET490	28	Polyamide Screws
ACGSL084	16	Sash Assembly Screws
ACET840	4 x (W-160) + 4 x (H-120)	Wedge Glazing Gasket
ACET842	4 x (W-160) + 4 x (H-120)	External Glazing Gasket
ACVS032B/W	4 x (W-84) + 8 x (H/2)	Woolpile
ACVS033	2 x W-84	Woolpile
ACVS034B/W	4 x (H/2)	Woolpile
ACVS023	1 Pair	VS023 End Caps
ACVS024	1 Pair	VS024 End Caps
ACVS040/ACVS041	1 Pair	VS010/VS110 End Caps
ACVS042	1	Balance Fixing Kit
ACVS043	4	VS023 Polyamide Support
ACVS052	1 Set	Travel Stops
ACVS057	16	Bridge Packer
PUA028	12	Outer Frame Screws
ACDR052	4	Outer Frame Screws

CALDWELL ACCESSORIES

Accessory	Quantity	Description
KL800 / NL800	1 (2 if over 800 wide)	Locking Sash Lock/Non locking Sash lock
30459	1 (2 if over 800 wide)	Keep
Ultralift	1 pair	Top Balances
Ultralift	1 pair	Bottom Balances
PE739	4	Pivot Shoes
UK526	4	Pivot Bar Carrier
UK507	4	Pivot Bar
UK469	4	Push-in Rivet
UK472L/R	4	Tilt Latch
UK858	2	Top Guide Latch Operating Button
UK545	2	Bottom Guide Latch Operating Button
RA*50RUQR	4	Tilt Restictor
UK624	1 (2 if over 800 wide)	Sash Ring
8790	1 (2 if over 800 wide)	Sash Lift Hook

Do Not Scale From This Drawing

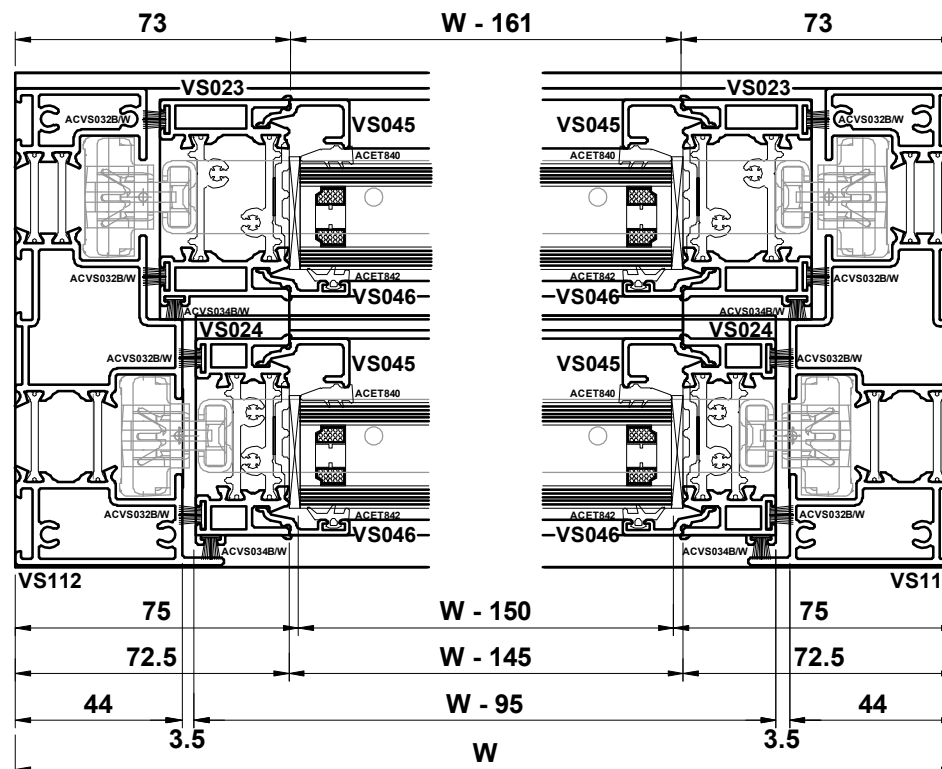
Cutting Information - Standard Bottom Rail with Slim Jamb



PROFILE CUTTING SCHEDULE

Profile	Quantity	Material	Dimensions
VS010/VS110	1	W	W
VS011	1	W	W
VS112	2	H - 50	H - 50
VS041	1	W - 110	W - 110
EF422	1	W	W
VS020	2	W - 145	W - 145
VS021	1	W - 145	W - 145
VS022	1	W - 145	W - 145
VS023/VS123	2	H2 - 14.5	H2 - 14.5
VS024/VS124	2	H1 - 20.5	H1 - 20.5
VS030/VS130	1	W - 95	W - 95
VS030/VS130	1	W - 76	W - 76
VS031	1	W - 147	W - 147
VS032	1	W - 147	W - 147
VS044/VS045	4	W - 147	W - 147
VS044/VS045	2	H2 - 86.5	H2 - 86.5
VS044/VS045	2	H1 - 93	H1 - 93
VS046	2	H2 - 86.5	H2 - 86.5
VS046	2	H1 - 93	H1 - 93
VS052	2	220	220
VS052	2	130	130

GLASS SIZES	Dimensions
1 x	H1 = W - 150 x H1 - 67
1 x	H2 = W - 150 x H2 - 60.5



ACCESSORIES

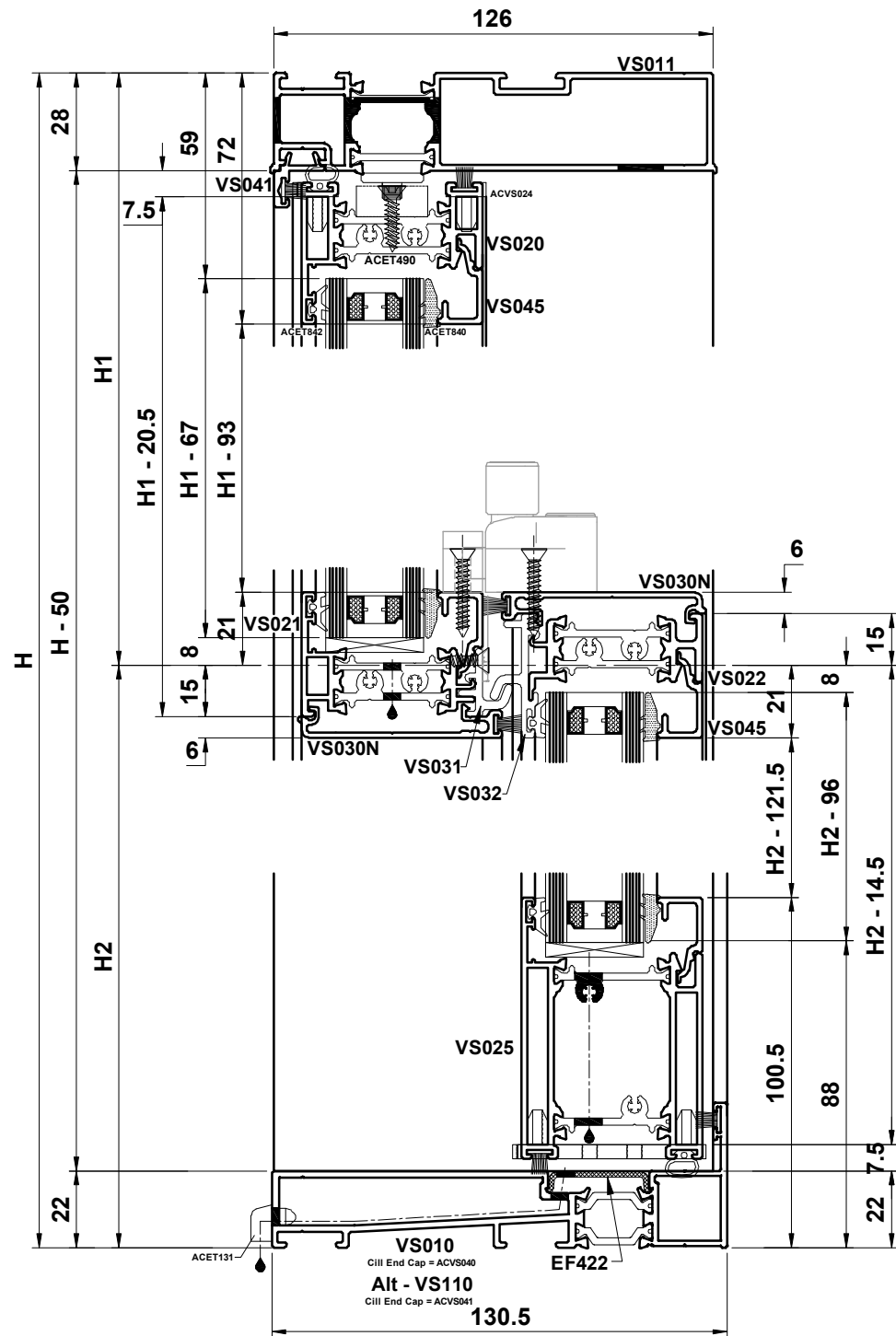
Accessory	Quantity	Description
ACDV268	2 x (W-70)	Bubble Gasket
ACET067	6	Lock & Keep Screws
ACET131	2	Drainage Cover Cap
ACET490	28	Polyamide Screws
ACGSL084	16	Sash Assembly Screws
ACET840	4 x (W-150) + 4 x (H-120)	Wedge Glazing Gasket
ACET842	4 x (W-150) + 4 x (H-120)	External Glazing Gasket
ACVS032B/W	4 x (W-70) + 8 x (H/2)	Woolpile (Approx Sizes)
ACVS033	2 x W-70	Woolpile (Approx Sizes)
ACVS034B/W	4 x (H/2)	Woolpile (Approx Sizes)
ACVS023	1 Pair	VS023 End Caps
ACVS024	1 Pair	VS024 End Caps
ACVS040/ACVS041	1 Pair	VS010/VS110 End Caps
ACVS042	1	Balance Fixing Kit
ACVS043	4	VS023 Polyamide Support
ACVS052	4	VS052 Travel Stop End Caps
ACVS057	16	Bridge Packer
PUA028	12	Outer Frame Screws
ACDR052	4	Outer Frame Screws

CALDWELL ACCESSORIES

Accessory	Quantity	Description
KL800 / NL800	1 (2 if over 800 wide)	Locking Sash Lock/Non locking Sash lock
30459	1 (2 if over 800 wide)	Keep
Ultralift	1 pair	Top Balances
Ultralift	1 pair	Bottom Balances
PE739	4	Pivot Shoes
UK526	4	Pivot Bar Carrier
UK507	4	Pivot Bar
UK469	4	Push-in Rivet
UK472/L/R	4	Tilt Latch
UK858	2	Top Guide Latch Operating Button
UK545	2	Bottom Guide Latch Operating Button
RA*50RUQR	4	Tilt Restictor
UK624	1 (2 if over 800 wide)	Sash Ring
8790	1 (2 if over 800 wide)	Sash Lift Hook

Do Not Scale From This Drawing

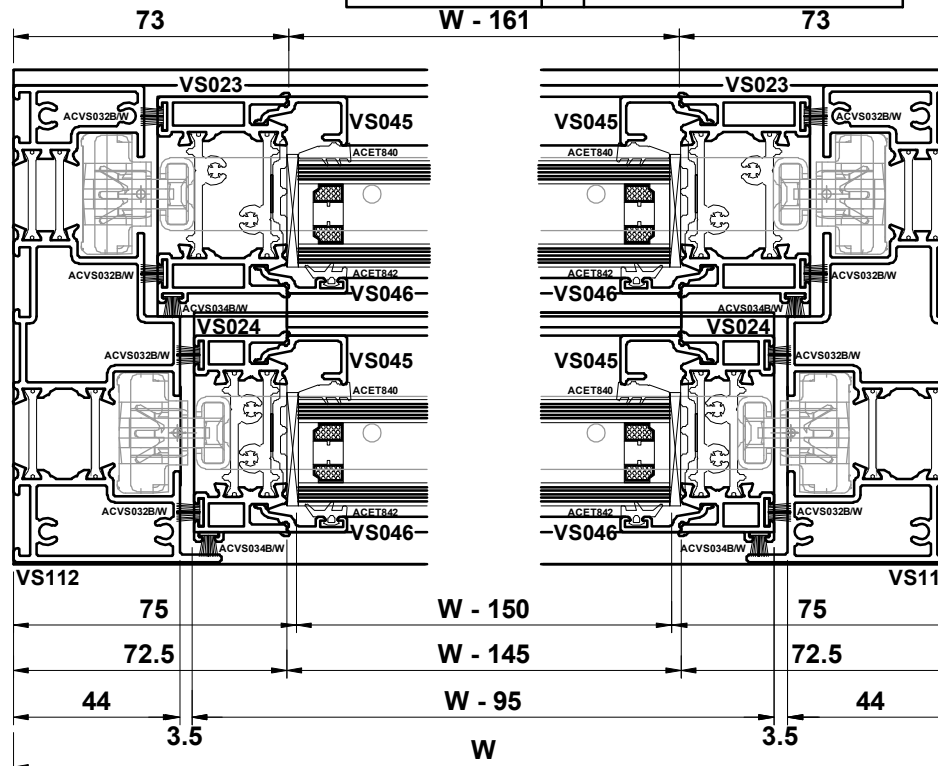
Cutting Information - Deep Bottom Rail with Slim Jamb



PROFILE CUTTING SCHEDULE

Profile	Quantity	Dimensions
VS010/VS110	1	W
VS011	1	W
VS112	2	H - 50
VS041	1	W - 110
EF422	1	W
VS020	1	W - 145
VS021	1	W - 145
VS022	1	W - 145
VS023/VS123	2	H2 - 14.5
VS024/VS124	2	H1 - 20.5
VS025	1	W - 145
VS030/VS130	1	W - 95
VS030/VS130	1	W - 76
VS031	1	W - 147
VS032	1	W - 147
VS044/VS045	4	W - 147
VS044/VS045	2	H2 - 121.5
VS044/VS045	2	H1 - 93
VS046	2	H2 - 121.5
VS046	2	H1 - 93
VS052	2	220
VS052	2	130

GLASS SIZES	Quantity	Dimensions
	1 x	H1 = W - 150 x H1 - 67
	1 x	H2 = W - 150 x H2 - 96



ACCESSORIES

Accessory	Quantity	Description
ACDV268	2 x (W-70)	Bubble Gasket
ACET067	6	Lock & Keep Screws
ACET131	2	Drainage Cover Cap
ACET490	28	Polyamide Screws
ACGSL084	16	Sash Assembly Screws
ACET840	4 x (W-160) + 4 x (H-120)	Wedge Glazing Gasket
ACET842	4 x (W-160) + 4 x (H-120)	External Glazing Gasket
ACVS032B/W	6 x (W-70) + 8 x (H/2)	Woolpile
ACVS033	2 x W-70	Woolpile
ACVS034B/W	4 x (H/2)	Woolpile
ACVS023	1 Pair	VS023 End Caps
ACVS024	1 Pair	VS024 End Caps
ACVS040/ACVS041	1 Pair	VS010/VS110 End Caps
ACVS042	1	Balance Fixing Kit
ACVS043	4	VS023 Polyamide Support
ACVS052	1 Set	Travel Stops
ACVS057	16	Bridge Packer
PUA028	12	Outer Frame Screws
ACDR052	4	Outer Frame Screws

CALDWELL ACCESSORIES

Accessory	Quantity	Description
KL800 / NL800	1 (2 if over 800 wide)	Locking Sash Lock/Non locking Sash lock
30459	1 (2 if over 800 wide)	Keep
Ultralift	1 pair	Top Balances
Ultralift	1 pair	Bottom Balances
PE739	4	Pivot Shoes
UK526	4	Pivot Bar Carrier
UK507	4	Pivot Bar
UK469	4	Push-in Rivet
UK472L/R	4	Tilt Latch
UK858	2	Top Guide Latch Operating Button
UK545	2	Bottom Guide Latch Operating Button
RA*50RUQR	4	Tilt Restictor
UK624	1 (2 if over 800 wide)	Sash Ring
8790	1 (2 if over 800 wide)	Sash Lift Hook

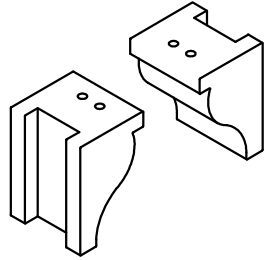
Do Not Scale From This Drawing

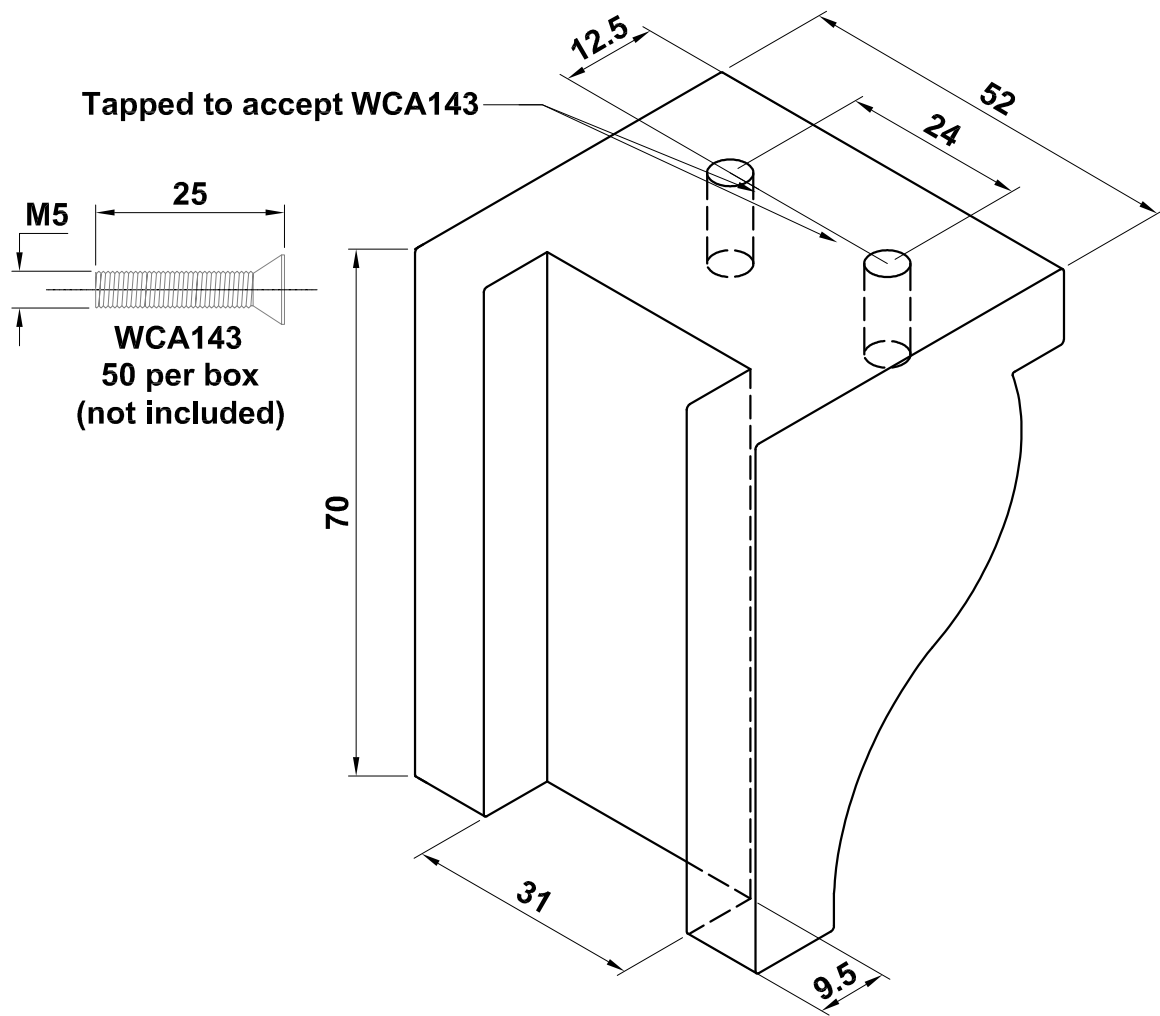
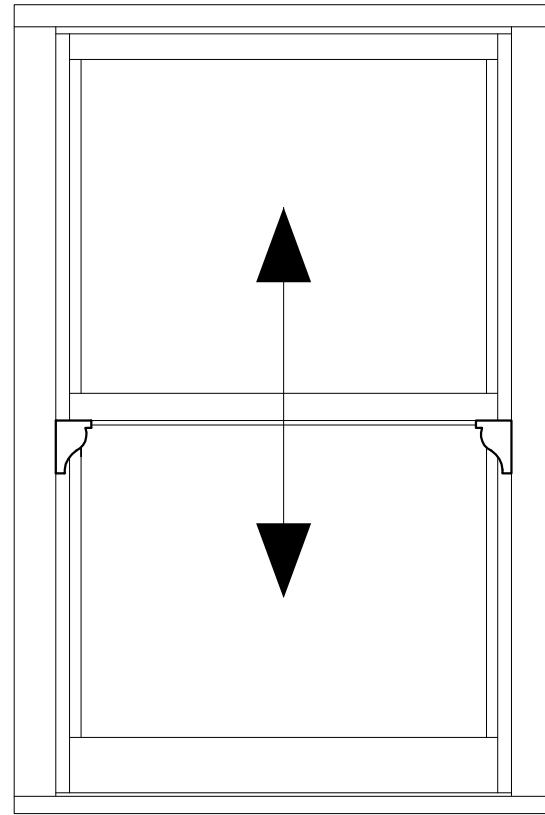
Cutting Information

Do Not Scale From This Drawing

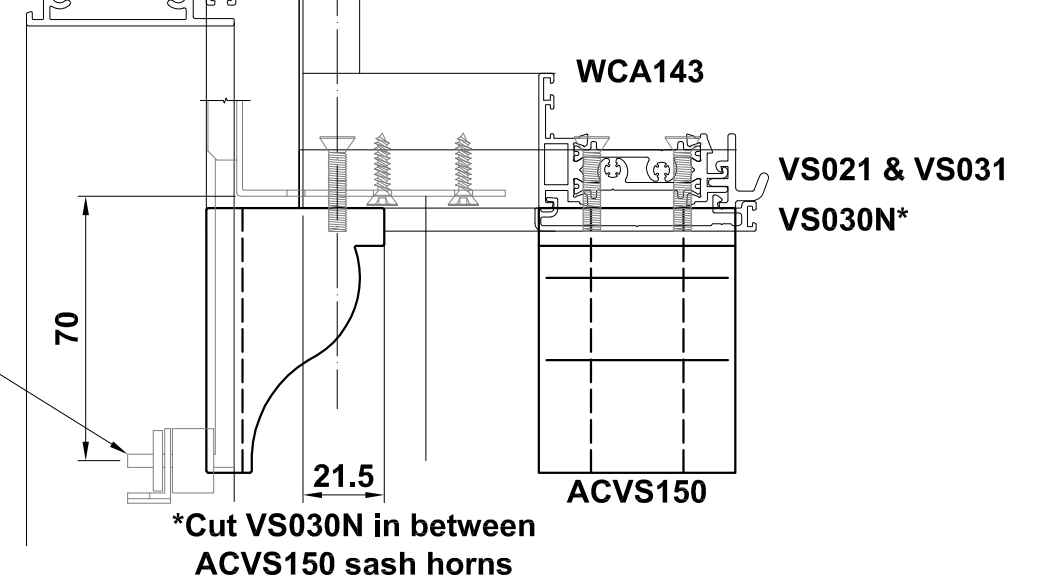
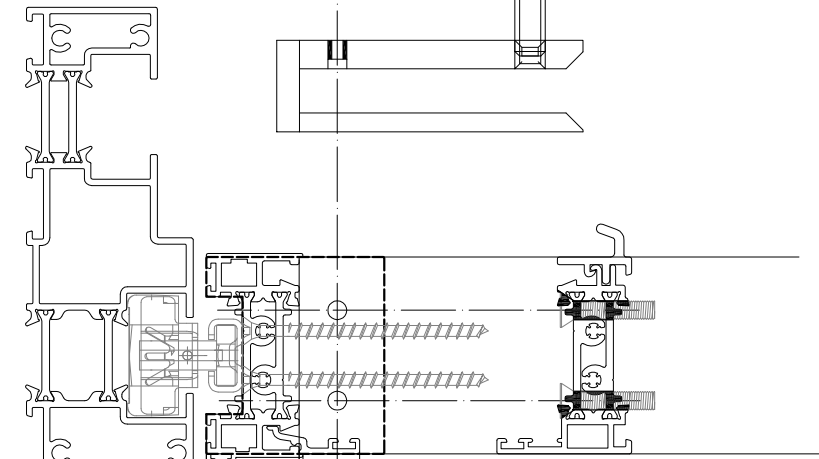
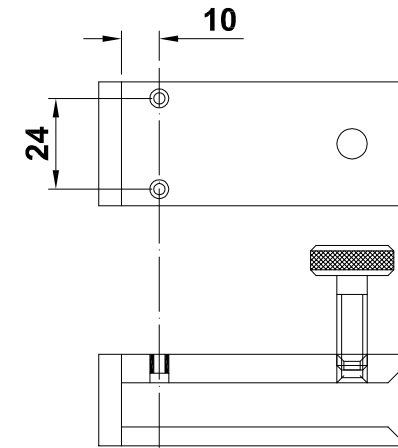
Bulletin

New sash horns to compliment the VS600 system.

Image	Part Code	Pack	Unit
	ACVS150 Sash Horns Powder coated to match frame	1	pair



ACVS903 - Drill Jig
Drill with 3mm bit and open up to a 6mm clearance hole and countersink to accept WCA143



Extended Pivot Bar
- See Caldwell

Do Not Scale From This Drawing